

S4L1S-D4 Wdg.311 - Technical Data Sheet

Standards

STAMFORD industrial alternators meet the requirements of the relevant parts of the IEC 60034 and the relevant sections of other international standards such as BS5000-3, ISO 8528-3, VDE 0530, NEMA MG1-32, CSA C22.2-100 and AS 60034. Other standards and certifications can be considered on request.

Quality Assurance

Alternators are manufactured using production procedures having a quality assurance level to BS EN ISO 9001.

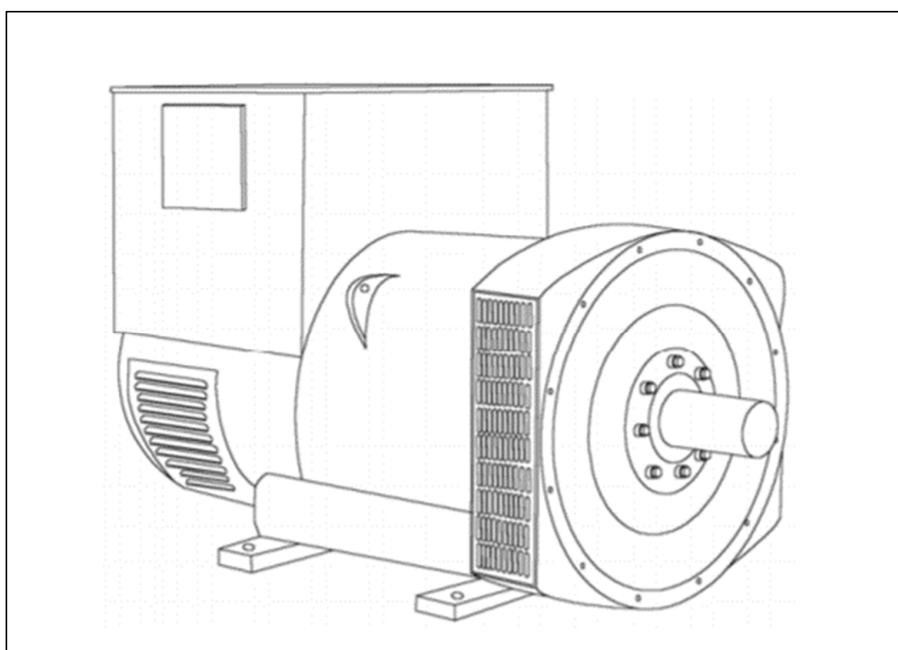

Excitation and Voltage Regulators

Excitation System					
AVR Type	AS440	MX341	MX321	MX322	
Voltage Regulation	± 1%	± 1%	± 0.5%	± 0.5%	with 4% Engine Governing
Excitation Type	Self-Excited	PMG	PMG	PMG	

No Load Excitation Voltage (V)	12 - 9
No Load Excitation Current (A)	0.7 - 0.5
Full Load Excitation Voltage (V)	41 - 39
Full Load Excitation Current (A)	2.3 - 2.2
Exciter Time Constant (seconds)	0.105

STAMFORD®

S4L1S-D4 Wdg.311

Electrical Data								
Insulation System	Class H							
Stator Winding	Double Layer Lap							
Winding Pitch	Two Thirds							
Winding Leads	12							
Winding Number	311							
Number of Poles	4							
IP Rating	IP23							
RFI Suppression	BS EN 61000-6-2 & BS EN 61000-6-4, VDE 0875G, VDE 0875N. Refer to factory for others							
Waveform Distortion	NO LOAD < 1.5% NON-DISTORTING BALANCED LINEAR LOAD < 5.0%							
Short Circuit Ratio	1/Xd							
Steady State X/R Ratio	12.29							
	50 Hz				60 Hz			
Telephone Interference	THF<2%				TIF<50			
Cooling Air	0.8 m³/sec				0.99 m³/sec			
Voltage Star	380	400	415	440	416	440	460	480
Voltage Parallel Star	190	200	208	220	208	220	230	240
Voltage Series Delta	220	230	240	254	240	254	266	277
kVA Base Rating (Class H) for Reactance Values	300	300	300	290	344	360	375	375
Saturated Values in Per Unit at Base Ratings and Voltages								
Xd Dir. Axis Synchronous	3.16	2.85	2.65	2.28	3.60	3.37	3.21	2.95
X'd Dir. Axis Transient	0.20	0.18	0.17	0.14	0.22	0.21	0.20	0.18
X''d Dir. Axis Subtransient	0.14	0.13	0.12	0.10	0.15	0.14	0.13	0.12
Xq Quad. Axis Reactance	2.66	2.40	2.23	1.92	3.09	2.89	2.75	2.53
X''q Quad. Axis Subtransient	0.40	0.36	0.33	0.29	0.40	0.38	0.36	0.33
XL Stator Leakage Reactance	0.07	0.06	0.06	0.05	0.09	0.08	0.08	0.07
X2 Negative Sequence Reactance	0.27	0.24	0.22	0.19	0.28	0.26	0.25	0.23
X0 Zero Sequence Reactance	0.10	0.09	0.08	0.07	0.10	0.09	0.09	0.08
Unsaturated Values in Per Unit at Base Ratings and Voltages								
Xd Dir. Axis Synchronous	3.79	3.42	3.18	2.73	4.32	4.04	3.85	3.54
X'd Dir. Axis Transient	0.23	0.21	0.19	0.17	0.25	0.24	0.23	0.21
X''d Dir. Axis Subtransient	0.17	0.15	0.14	0.12	0.17	0.16	0.15	0.14
Xq Quad. Axis Reactance	2.74	2.47	2.30	1.97	3.18	2.98	2.84	2.61
X''q Quad. Axis Subtransient	0.48	0.43	0.40	0.35	0.48	0.45	0.43	0.40
XL Stator Leakage Reactance	0.08	0.07	0.06	0.05	0.10	0.09	0.09	0.08
Xlr Rotor Leakage Reactance	0.12	0.11	0.10	0.09	0.14	0.13	0.12	0.11
X2 Negative Sequence Reactance	0.32	0.29	0.27	0.23	0.34	0.32	0.30	0.28
X0 Zero Sequence Reactance	0.12	0.11	0.10	0.08	0.11	0.11	0.10	0.09

STAMFORD®

S4L1S-D4 Wdg.311

Time Constants (Seconds)		
T'd TRANSIENT TIME CONST.	0.08	
T''d SUB-TRANSTIME CONST.	0.019	
T'do O.C. FIELD TIME CONST.	1.7	
Ta ARMATURE TIME CONST.	0.018	
T''q SUB-TRANSTIME CONST.	0.0304	
Resistances in Ohms (Ω) at 22°C		
Stator Winding Resistance (Ra), per phase for series connected	0.0124	
Rotor Winding Resistance (Rf)	1.05	
Exciter Stator Winding Resistance	18	
Exciter Rotor Winding Resistance per phase	0.068	
PMG Phase Resistance (Rpmg) per phase	1.9	
Positive Sequence Resistance (R1)	0.0155	
Negative Sequence Resistance (R2)	0.017856	
Zero Sequence Resistance (R0)	0.0155	
Saturation Factors	400V	480V
SG1.0	0.31	0.31
SG1.2	1.25	1.25
Mechanical Data		
Shaft and Keys	All alternator rotors are dynamically balanced to better than BS6861: Part 1 Grade 2.5 for minimum vibration in operation. Two bearing generators are balanced with a half key.	
	1 Bearing	2 Bearings
SAE Adaptor	SAE 0,0.5,1,2,3	SAE 0,0.5,1,2
Moment of Inertia	4.0771 kgm2	3.8783 kgm2
Weight Wound Stator	415 kg	415 kg
Weight Wound Rotor	361 kg	338 kg
Weight Complete Alternator	940 kg	950 kg
Shipping weight in a Crate	1010 kg	1010 kg
Packing Crate Size	155 x 87 x 107(cm)	156 x 87 x 107(cm)
Maximum Over Speed	2250 RPM for two minutes	
Bearing Drive End	N/A	Ball 6317
Bearing Non-Drive End	Ball 6314	Ball 6314

STAMFORD®

S4L1S-D4 Wdg.311

THREE PHASE EFFICIENCY CURVES

50Hz

60Hz

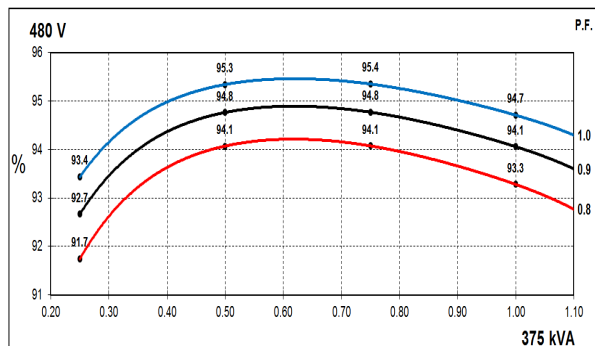
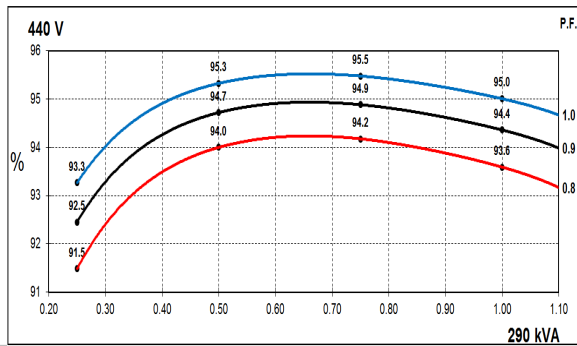
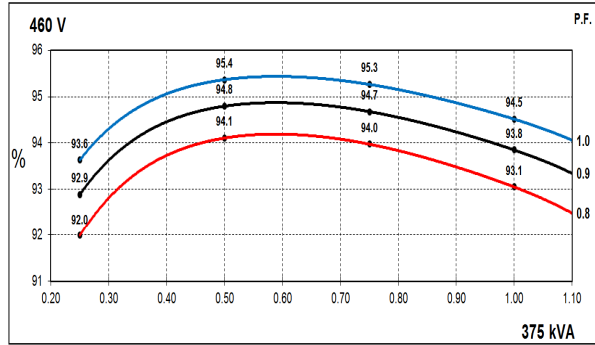
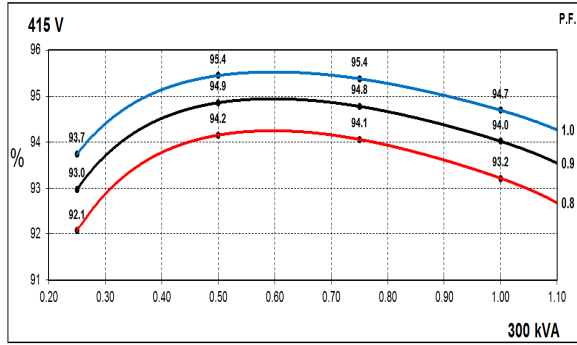
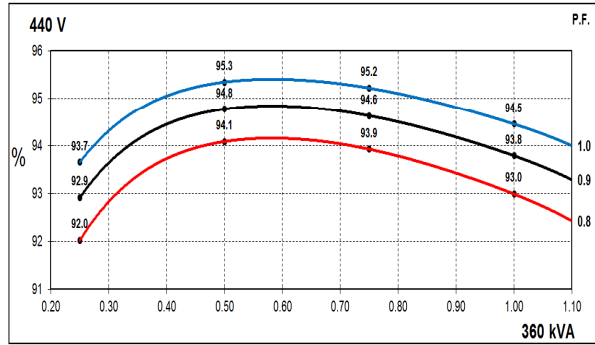
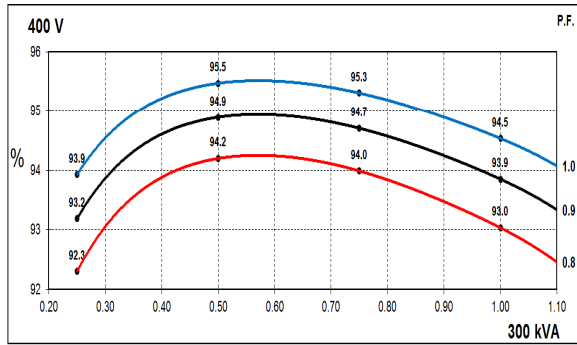
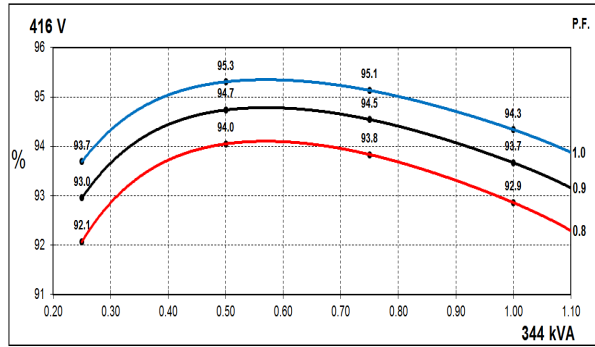
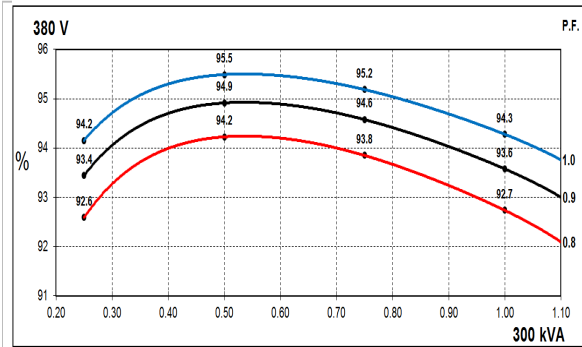

STAMFORD

S4L1S-D4 Wdg.311

Locked Rotor Motor Starting Curves - Separately Excited

50Hz

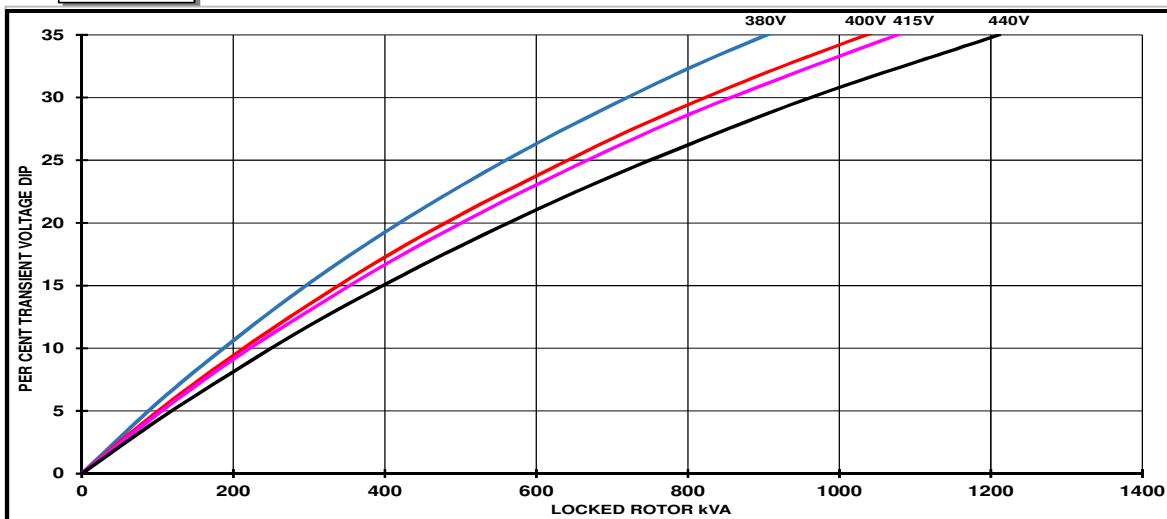

60Hz

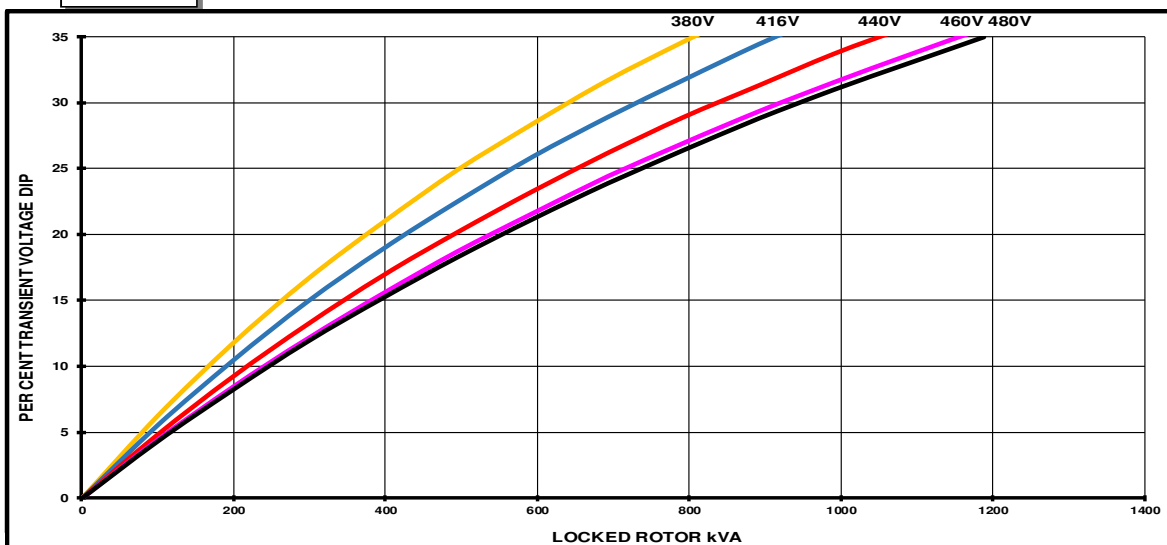

Transient Voltage Dip Scaling Factor		Transient Voltage Rise Scaling Factor	
Lagging PF	Scaling Factor	Lagging PF	Scaling Factor
<= 0.4	1.00	<= 0.4	1.25
0.5	0.95	0.5	1.20
0.6	0.90	0.6	1.15
0.7	0.86	0.7	1.10
0.8	0.83	> 0.7	1.00
0.9	0.75		
0.95	0.70		
1	0.65		

Note: To determine % Transient Voltage Dip or Voltage Rise at various PF, multiply the % Voltage Dip from the curve directly by the Scaling Factor.

STAMFORD

S4L1S-D4 Wdg.311

Locked Rotor Motor Starting Curves - Self Excited

50Hz

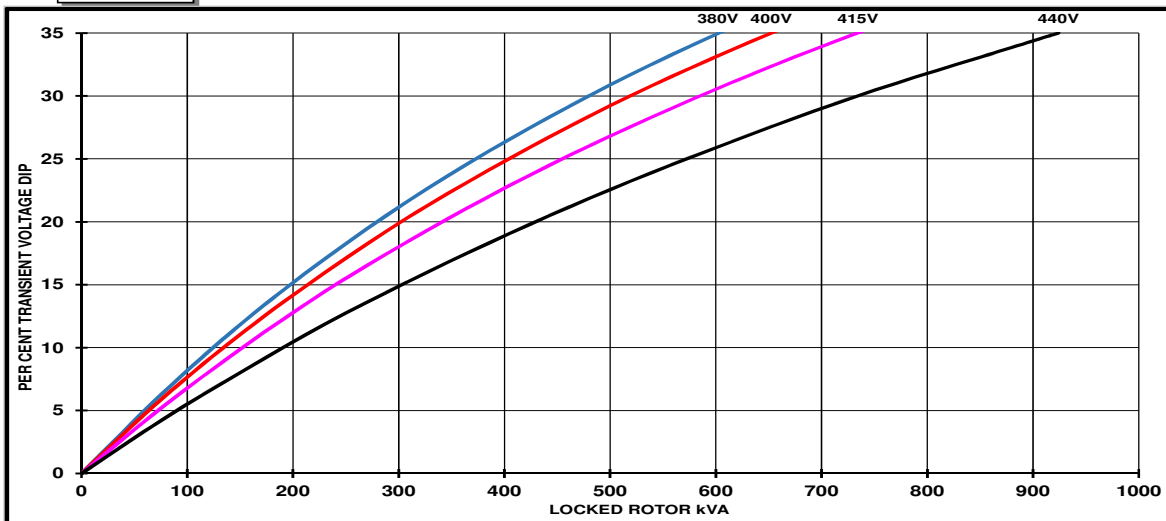

60Hz

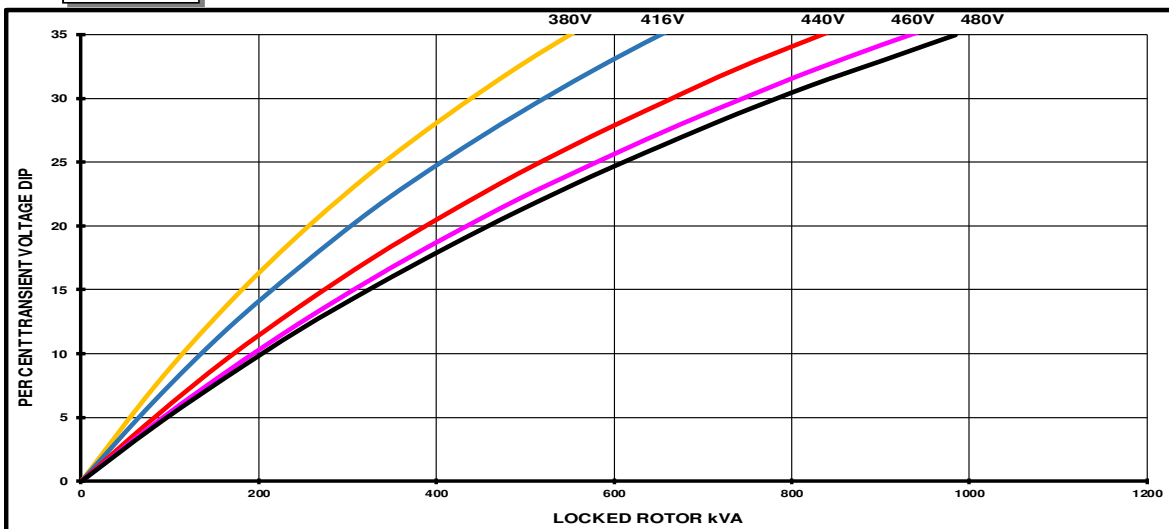

Transient Voltage Dip Scaling Factor		Transient Voltage Rise Scaling Factor	
Lagging PF	Scaling Factor	Lagging PF	Scaling Factor
<= 0.4	1.00	<= 0.4	1.25
0.5	0.95	0.5	1.20
0.6	0.90	0.6	1.15
0.7	0.86	0.7	1.10
0.8	0.83	> 0.7	1.00
0.9	0.75		
0.95	0.70		
1	0.65		

Note: To determine % Transient Voltage Dip or Voltage Rise at various PF, multiply the % Voltage Dip from the curve directly by the Scaling Factor.

STAMFORD®

S4L1S-D4 Wdg.311

Three-phase Short Circuit Decrement Curve

50Hz

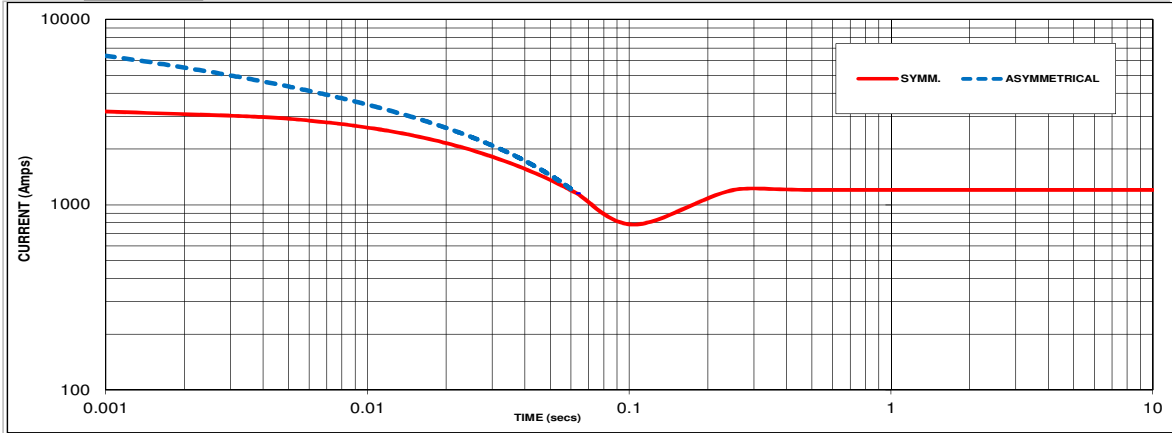

Sustained Short Circuit = 1200 Amps

60Hz

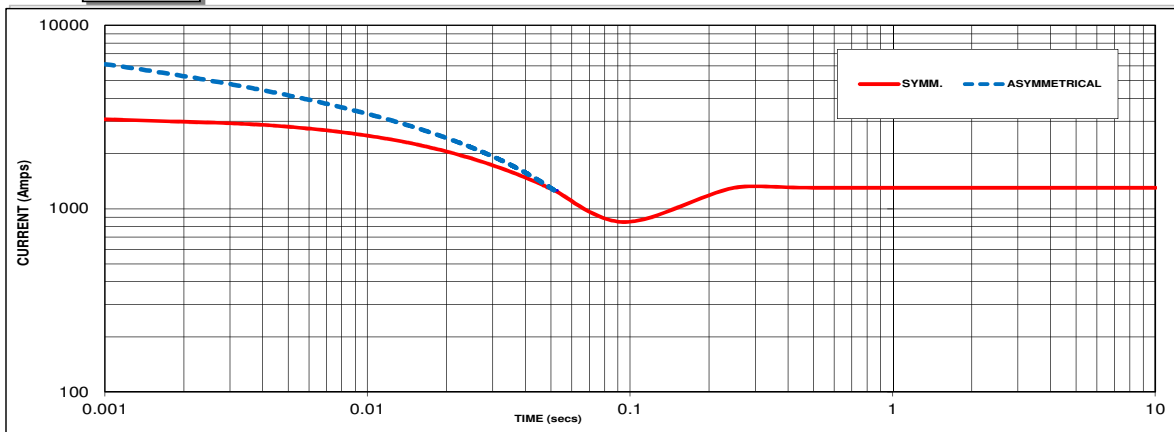

Sustained Short Circuit = 1300 Amps

Note 1

The following multiplication factors should be used to adjust the values from curve between time 0.001 seconds and the minimum current point in respect of nominal operating voltage :

50Hz		60Hz	
Voltage	Factor	Voltage	Factor
380V	X 1.00	416V	X 1.00
400V	X 1.05	440V	X 1.06
415V	X 1.09	460V	X 1.10
440V	X 1.16	480V	X 1.15

The sustained current value is constant irrespective of voltage level

If MX322 or digital AVR is used, the sustained short circuit current value is to be multiplied by a factor of 1.1.

Note 2

The following multiplication factor should be used to convert the values calculated in accordance with NOTE 1 to those applicable to the various types of short circuit :

	3-phase	2-phase L-L	1-phase L-N
Instantaneous	x 1.00	x 0.87	x 1.30
Minimum	x 1.00	x 1.80	x 3.20
Sustained	x 1.00	x 1.50	x 2.50
Max. sustained duration	10 sec.	5 sec.	2 sec.

All other times are unchanged

Note 3

Curves are drawn for Star connected machines under no-load excitation at rated speeds. For other connection the following multipliers should be applied to current values as shown :
 Parallel Star = Curve current value X 2
 Series Delta = Curve current value X 1.732

STAMFORD®

S4L1S-D4 Wdg.311

Typical Alternator Operating Charts

400V/50Hz

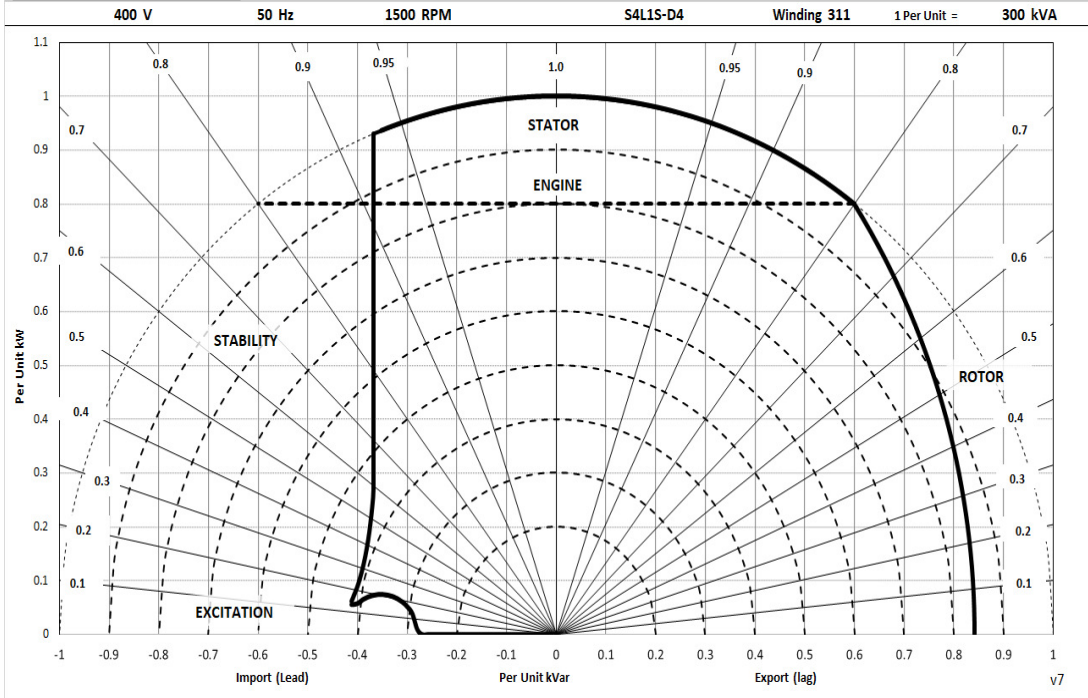

480V/60Hz

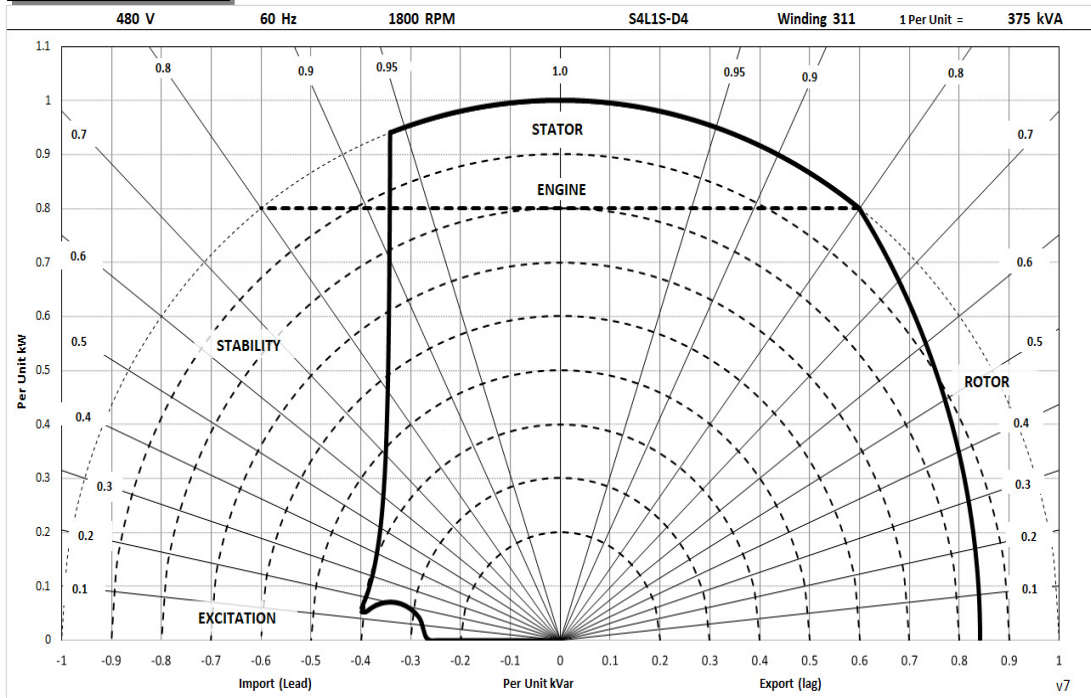

STAMFORD®

S4L1S-D4 Wdg.311

RATINGS AT 0.8 POWER FACTOR

Class - Temp Rise		Standby - 163/27°C				Standby - 150/40°C				Cont. H - 125/40°C				Cont. F - 105/40°C			
50 Hz	Series Star (V)	380	400	415	440	380	400	415	440	380	400	415	440	380	400	415	440
	Parallel Star (V)	190	200	208	220	190	200	208	220	190	200	208	220	190	200	208	220
	Series Delta (V)	220	230	240	254	220	230	240	254	220	230	240	254	220	230	240	254
	kVA	330	330	330	320	320	320	320	310	300	300	300	290	280	280	280	270
	kW	264	264	264	256	256	256	256	248	240	240	240	232	224	224	224	216
	Efficiency (%)	92.1	92.5	92.7	93.2	92.3	92.7	92.9	93.3	92.7	93.0	93.2	93.6	93.1	93.4	93.5	93.8
	kW Input	287	285	285	275	277	276	276	266	259	258	258	248	241	240	240	230

60 Hz	Series Star (V)	416	440	460	480	416	440	460	480	416	440	460	480	416	440	460	480
	Parallel Star (V)	208	220	230	240	208	220	230	240	208	220	230	240	208	220	230	240
	Series Delta (V)	240	254	266	277	240	254	266	277	240	254	266	277	240	254	266	277
	kVA	375	395	415	415	365	385	400	400	344	360	375	375	315	335	345	345
	kW	300	316	332	332	292	308	320	320	275	288	300	300	252	268	276	276
	Efficiency (%)	92.4	92.5	92.5	92.8	92.5	92.6	92.7	93.0	92.9	93.0	93.1	93.3	93.3	93.3	93.4	93.6
	kW Input	325	342	359	358	316	333	345	344	296	310	322	322	270	287	296	295

De-Rates

All values tabulated above are subject to the following reductions:

- 5% when air inlet filters are fitted
- 3% for every 500 meters by which the operating altitude exceeds 1000 meters above mean sea level
- 3% for every 5°C by which the operational ambient temperature exceeds 40°C
- For any other operating conditions impacting the cooling circuit please refer to applications

Note: Requirement for operating in an ambient exceeding 60°C and altitude exceeding 4000 meters must be referred to applications.

Dimensional and Torsional Drawing

For dimensional and torsional information please refer to the alternator General Arrangement and rotor drawings available on our website (<http://stamford-avk.com/>)

Note: Continuous development of our products means that the information contained in our data sheets can change without notice, and specifications should always be confirmed with Cummins Generator Technologies prior to purchase.



Follow us @stamfordavk



Cummins Generator Technologies



View our videos at youtube.com/stamfordavk

stamford-avk.com

For Applications Support:
applications@cummins.com

For Customer Service:
emea.service@cummins.com

For General Enquiries:
stamford-avk@cummins.com

Copyright 2020. Cummins Generator Technologies Ltd. All rights reserved.
Cummins and the Cummins logo are registered trade marks of Cummins Inc.
STAMFORD is a registered trade mark of Cummins Generator Technologies Ltd.

