

Technical Data

4000 Series

4016-61TRS1

4016-61TRS2

Gas Engine

1500 rev/min

Basic technical data

Number of cylinders .. 16
 Cylinder arrangement ... 60° Vee
 Cycle ... 4 stroke
 Induction system ... turbocharged, air to water charge cooled
 Combustion system ... spark ignition
 Compression ratio ... 12:1
 Bore ... 160 mm
 Stroke ... 190 mm
 Cubic capacity ... 61.123 litres
 Direction of rotation ... anti-clockwise viewed on flywheel
 Firing order ... 1A, 1B, 3A, 3B, 7A, 7B, 5A, 5B,
 ... 8A, 8B, 6A, 6B, 2A, 2B, 4A, 4B
 Cylinder 1 ... furthest from flywheel

Ratings

This is defined in ISO3046/1, BS5514 and DIN 6271
 Electrical ratings are based on stated alternator efficiency and are for guidance only. For Load Acceptance figures, please refer to Stafford Applications Engineering Department.

Operating point

Engine speed ... 1500 rev/min
 Ignition timing ... 26° BTDC
 Inlet manifold mixture temperature ... 45 °C
 Cooling water exit temperature ... < 96°C
 Exhaust emission ... according to TA-Luft (NOx)

Fuel data

Lower calorific value ... 34710 kJ/Sm³
 Density ... 0,76 kg/Sm³
 Stoich air requirement ... 16 kg/kg
 Minimum methane number before derate ... 75

Overall weight (all engines) and dimensions

Model	Height mm	Length mm	Width mm	Weight (dry) kg	Weight (wet) kg
Cogeneration unit					
Bio gas	1979	2949	1660	5820	6158
Natural gas	1969	2949	1737	5820	6158
Electro unit					
Natural gas	1969	3192	1737	5820	6158

Performance

Steady state speed stability at constant load ... ± 0,75%
Note: All data based on operation to ISO 3046/1, BS 5514 and DIN 6271 standard reference conditions.

Governing type ... Digital speed governor

Centre of Gravity (all engines)

Forward of rear face of cylinder block ... tba
 Above crankshaft centre line ... tba

Test conditions

-air temperature ... 25 °C
 -barometric pressure ... 100 kPa
 -relative humidity ... 30%

Moment of inertia (mk²)

-engine ... 8,65 kgm²
 -flywheel ... 9,57 kgm²
 Cyclic irregularity for engine/flywheel ... 1:312

General installation

Designation	Units	Continuous baseload rating			
		Cogeneration unit		Electro unit	
		TRS1	TRS2	TRS1	TRS2
Gross engine power	kW	912	1042	912	1042
Brake mean effective pressure	kPa	1193	1364	1193	1364
Combustion air flow	m ³ /min	68,3	78,8	69,1	79,7
Exhaust gas temperature (max) before turbo	°C	594	600	594	600
Exhaust gas temperature (max) after turbo	°C	482	468	482	468
Exhaust gas flow (max)	m ³ /min	178	205	180	207
Exhaust gas mass flow	kg/s	1,4	1,6	1,4	1,6
Boost pressure ratio	-	2,5	2,8	2,5	2,8
Overall electrical efficiency	%	38,4	38,6	37,6	37,8
Charge coolant flow	l/sec	350			
Nominal excess air factor (Lambda)	λ	1,7			
Typical gross Genset 25 °C (100 kPa) Electrical output (unity 1.0pf)	kWe	875	1000	875	1000
Assumed alternator efficiency	%	96			

Baseload rating: Unlimited hours usage with an average load factor of 100% of the published baseload power rating.

Energy balance

4016-61TRS1&2- Cogeneration unit

Designation	Units	Continuous Baseload rating			
		TRS1		TRS2	
		Value	%	Value	%
Energy in fuel	kWt	2288	100	2584	100
Energy in power output (Net)	kWb	912	39,8	1042	40,3
Energy in exhaust (25°C)	kWt	661	28,9	803	31,1
Energy to exhaust (120°C)	kWt	539	23,6	646	25,0
Energy to coolant and oil	kWt	487	21,3	445	17,2
Energy to charge cooler	kWt	134	5,9	180	7,0
Energy to radiation (exhaust temp. 25°C)	kWt	95	4,1	114	4,4

4016-61TRS1&2 - ElectroUnit

Designation	Units	Continuous Baseload rating			
		TRS1		TRS2	
		Value	%	Value	%
Energy in fuel	kWt	2334	100	2630	100
Energy in power output (Net)	kWb	912	39,1	1042	39,6
Energy in exhaust (25°C)	kWt	661	28,3	803	30,5
Energy to exhaust (120°C)	kWt	539	23,1	646	24,6
Energy to coolant and oil	kWt	501	21,5	459	17,5
Energy to charge cooler	kWt	148	6,4	194	7,4
Energy to radiation (exhaust temp. 25°C)	kWt	113	4,8	132	5,0

Not to be used for CHP design purposes (indicative figures only). Consult Perkins Engines Company Limited. Assumes complete combustion.

Cooling system

Recommended coolant: 50% inhibited ethylene glycol or 50% inhibited propylene glycol and 50% clean fresh water. For combined heat and power systems and where there is no likelihood of ambient temperature below 10 °C, then clean 'soft' water may be used, treated with 1% by volume of Perkins inhibitor in the cooling system. The inhibitor is available in 1 litre bottles from Perkins. Total coolant capacity (engine only) ... 95 litres
Maximum jacket water pressure in crankcase ... 100 kPa (plus static pressure head)

Jacket cooling water data

Total coolant flow ... 950 l/min
Coolant exit temperature (max) ... 96 °C
Coolant entry temperature (max) ... 81 °C

Charge cooling water data

Coolant flow ... 600 l/min
Coolant entry temperature ... 36 °C
Coolant exit temperature ... 40 °C
Charge cooler ... fin and tube on engine x2
Shutdown switch setting ... 193 kPa falling
Coolant immersion heater capacity ... 4 kW 1 off

Lubrication system

Recommended lubricating oil: Lubricating oil requirements vary with fuel used. Full specifications including oil sampling and recommendations and condemnation limits appear on the Fuel, Coolant and Lubricating Oil Recommendation Sheet for the 4000 Series Gas Engines.

Lubricating oil capacity

Total system capacity ... 286 litres
Sump maximum ... 257 litres
Sump minimum ... 147 litres

Lubricating oil temperature

Oil temperature in rail (continuous operation) ... 88 °C
Lubricating oil pressure at rated speed ... 470 kPa
Lubricating oil flow at 1500 rev/min ... 402 l/min
Sump drain plug tapping size ... GA1
Oil pump ... gear driven
Shutdown switch setting ... 193 kPa falling
Oil filter screen spacing ... 20 microns
Oil consumption after running in ... 0,25 g/kWhr

Normal operating angles:

-front and rear ... 5°
-side tilt ... 10°

Ignition system

Type ... electronic ignition system
Primary voltage ... 24V
Polarity ... Negative earth
Spark plug type ... Pre-chamber

Fuel system

Recommended fuel: Natural Gas LHV at 34 MJ/m³ (930 Btu/cu.ft). Other fuels may be used, for example landfill or digester gas.

Ratings will vary from those shown.

Where fuels other than Natural Gas are being considered you must obtain a full gas analysis including details of any solid or liquid components. Refer results to Perkins Engines Company Limited to determine suitability. Gas supplies must be filtered to the same standard as the engine intake air (i.e. Maximum particle size not to exceed 50 microns).

Minimum gas supply pressure ... 5 kPa
Maximum gas supply pressure ... 25 kPa
Fuel system type ... Electronic AFR control system
Installation of gas supply and shut off valves to be in accordance with local regulations.

Designation	Cogeneration unit		ElectroUnit	
	TRS1	TRS2	TRS1	TRS2
Fuel consumption gross	kJ / kWts	kJ / kWts	kJ / kWts	kJ / kWts
100% Continuous baseload rating	2,51	2,48	2,56	2,53
75% of Continuous base load rating	2,60	2,58	2,63	2,60
50% of Continuous baseload rating	2,68	2,66	2,70	2,68
25% of Continuous base rating	2,75	2,74	2,77	2,76

Fuel: Natural Gas - LHV = 34,71 MJ/m³

Tolerance on Fuel consumption

Designation		Cogeneration unit		ElectroUnit	
Mass flow data	Units	TRS1	TRS2	TRS1	TRS2
Fuel	Kg/h	180	203	183	207
Volume flow data					
Fuel (15 °C)	m ³ /hr	237	268	241	273

4016-61TRS1&2 Bio gas cogeneration unit - Left view

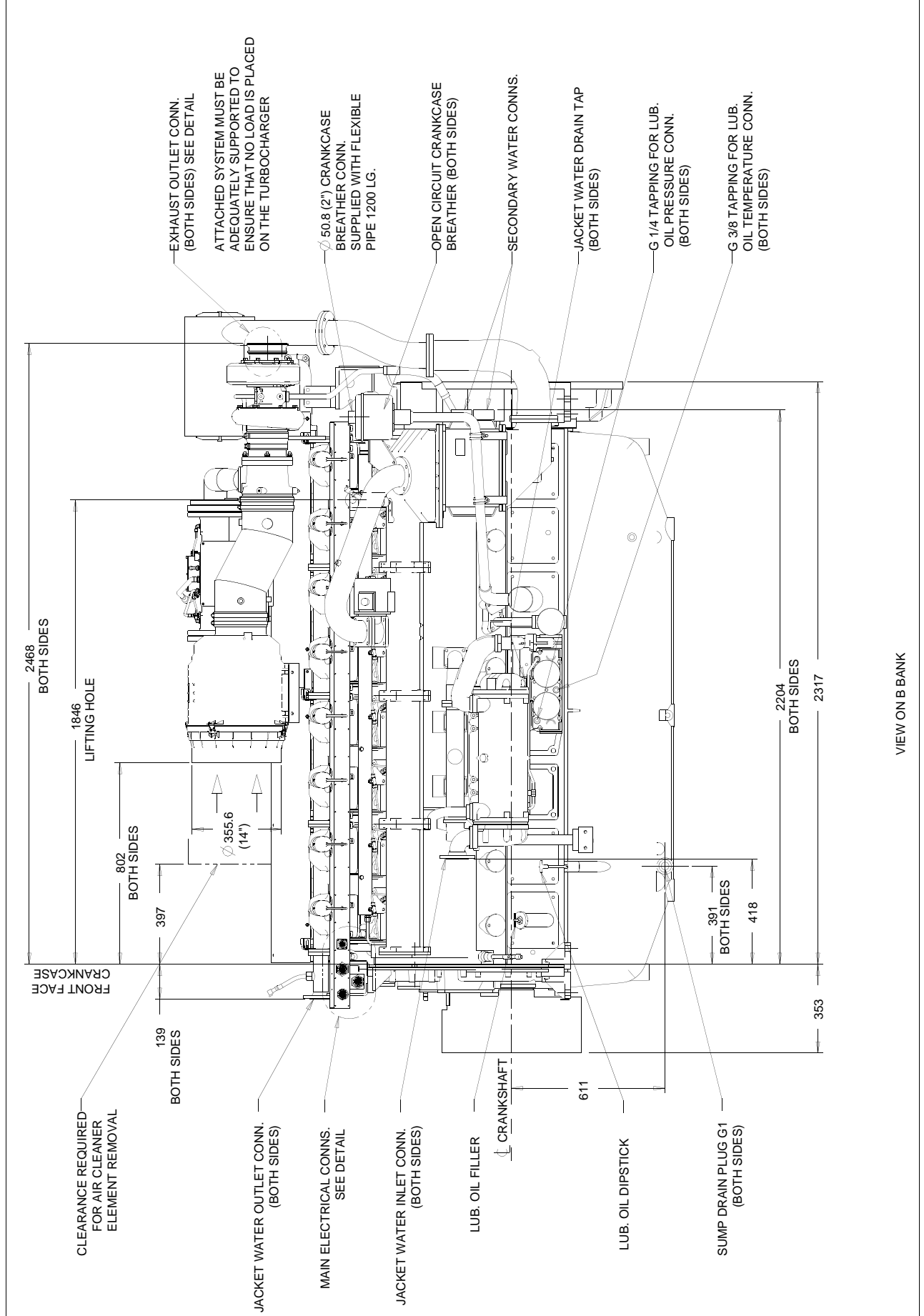

4016-61TRS1&2 Bio gas cogeneration unit - Front view

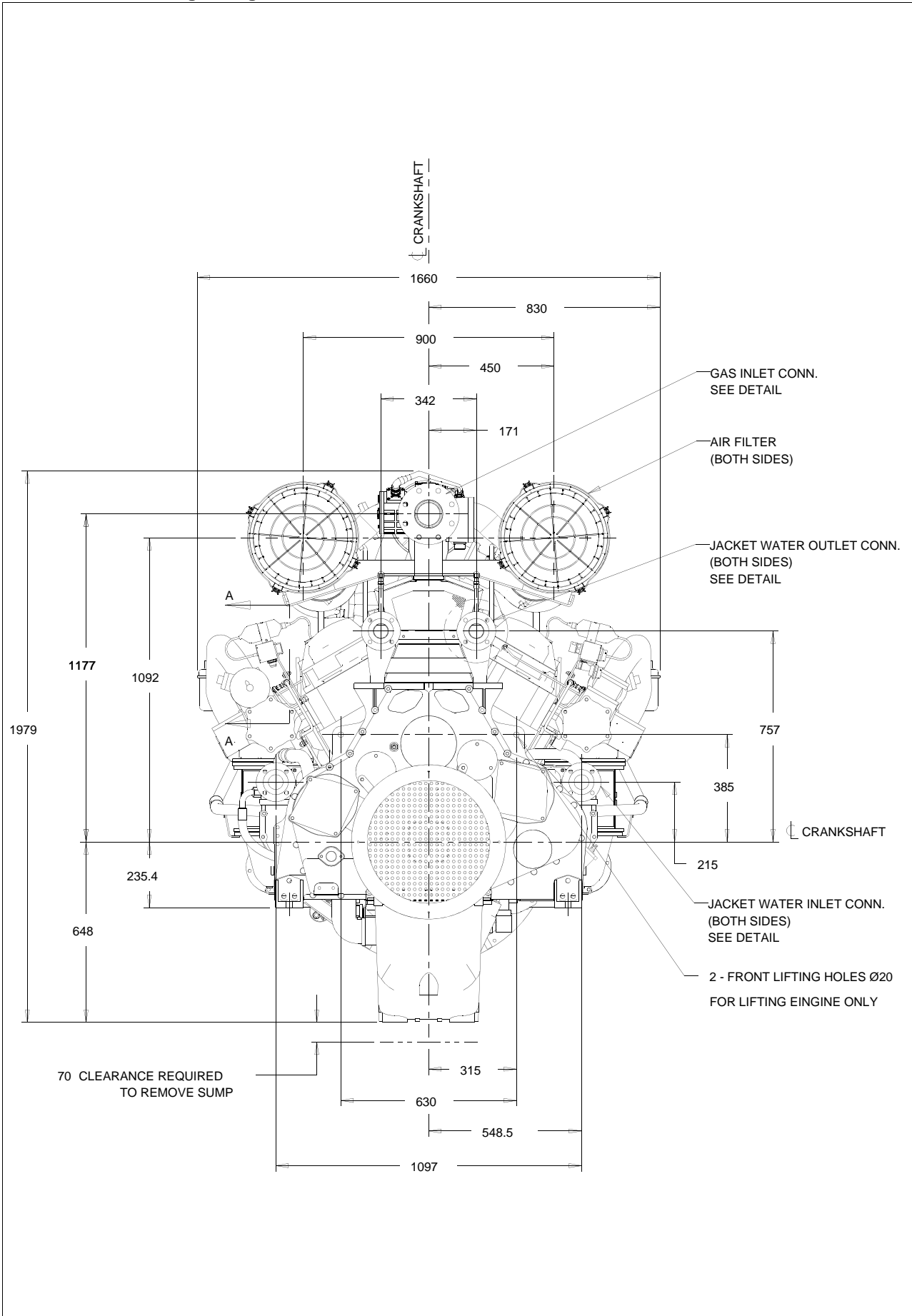

4016-61TRS1&2 Bio gas cogeneration unit - Right view

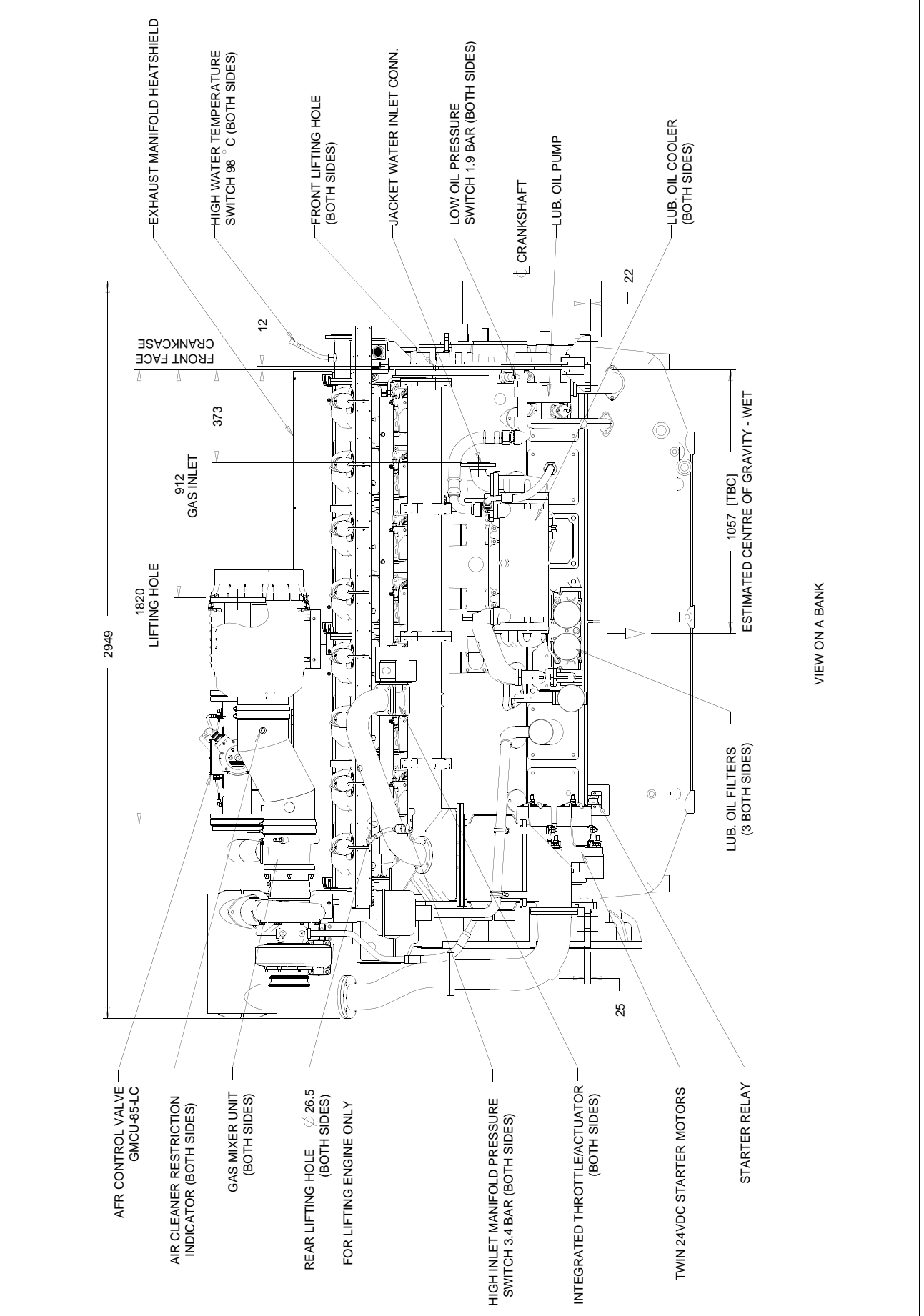

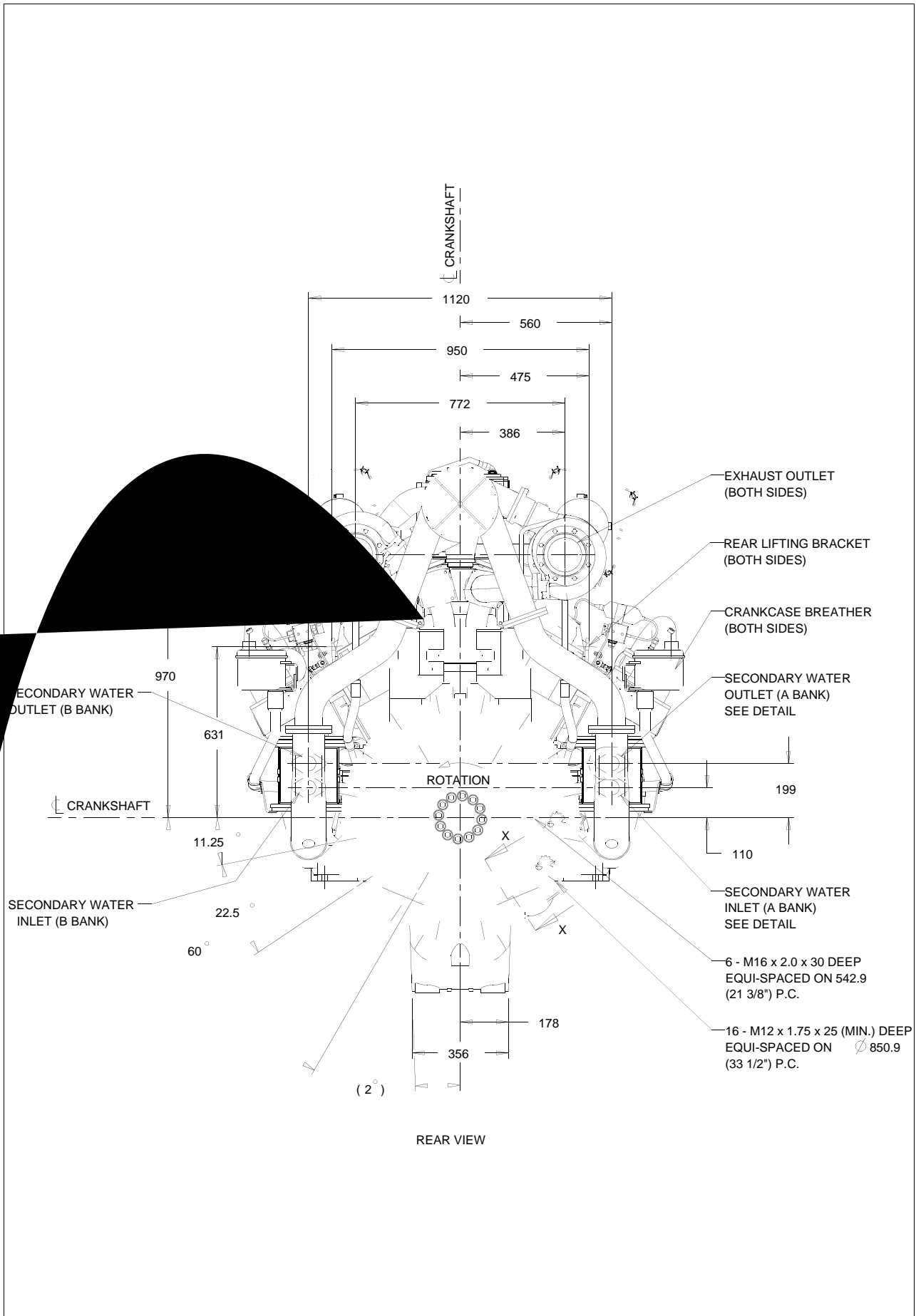

4016-61TRS1&2 Bio gas cogeneration unit - Electrical connections, Exhaust Outlet and Support Pads

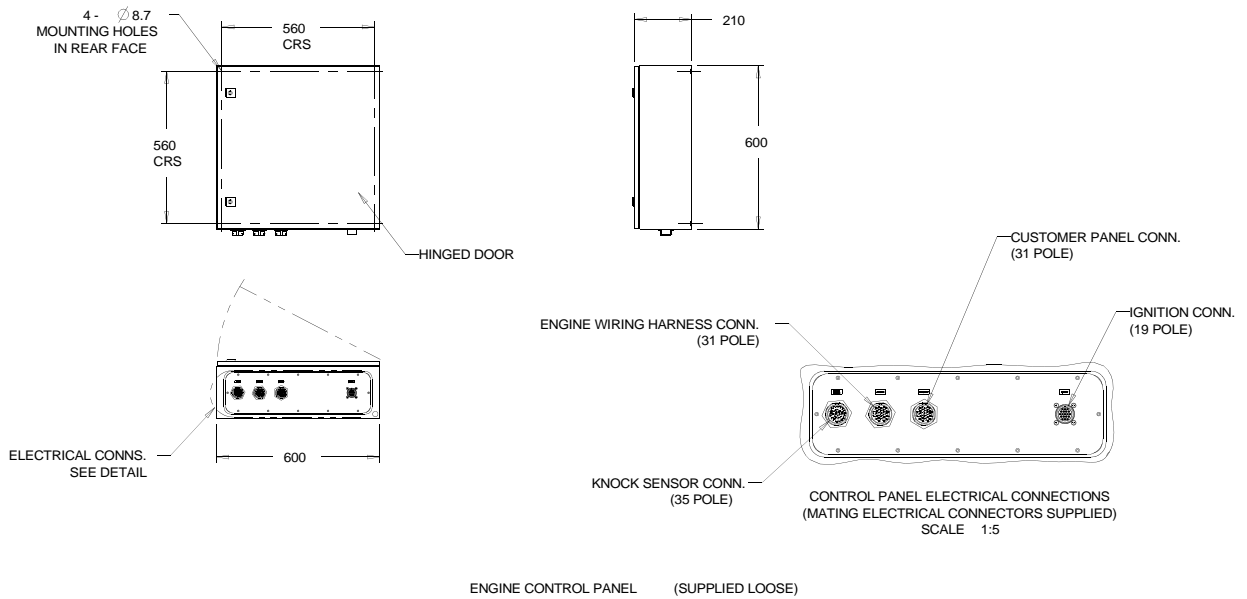

NOTE *
IGNITION AND KNOCK SENSOR CONNECTIONS ARE FOR INTEGRATED HARNESS (SUPPLIED FITTED) FROM B BANK WIRING RAIL

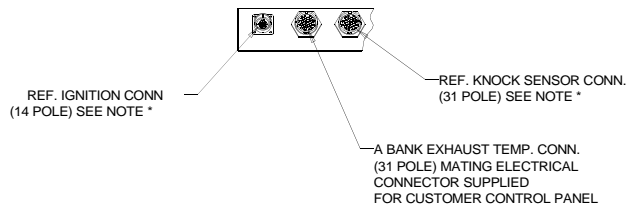

VIEW A-A
SHOWING ELECTRICAL CONNECTIONS ON A BANK WIRING RAIL
SCALE 1:5

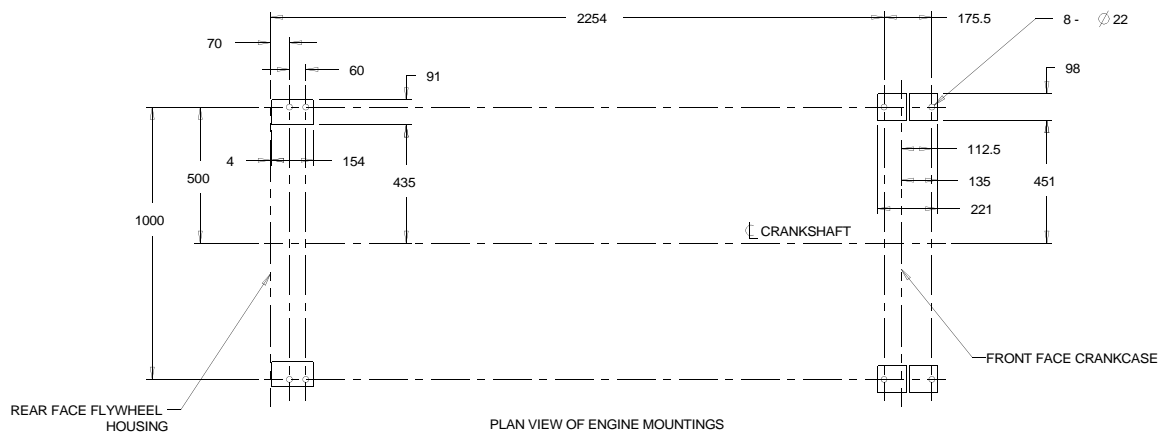
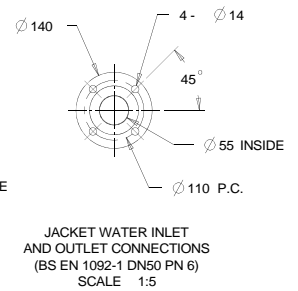
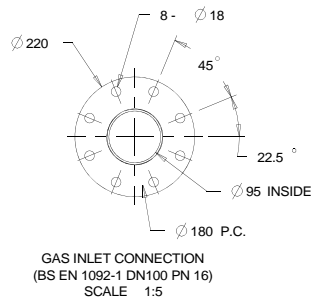

4016-61TRS1&2 Natural gas electro unit - Left view

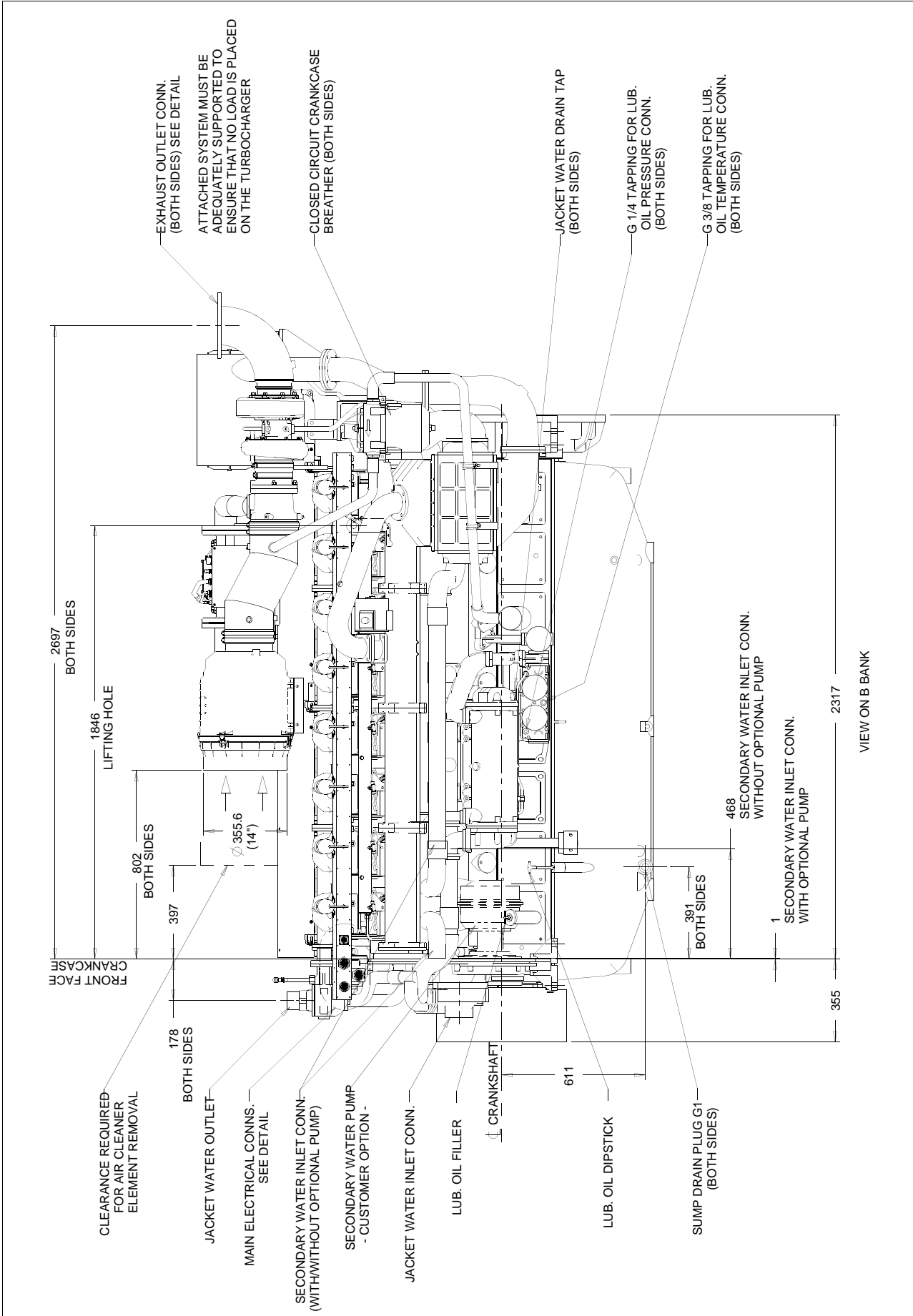

4016-61TRS1&2 Natural gas electro unit - Front view

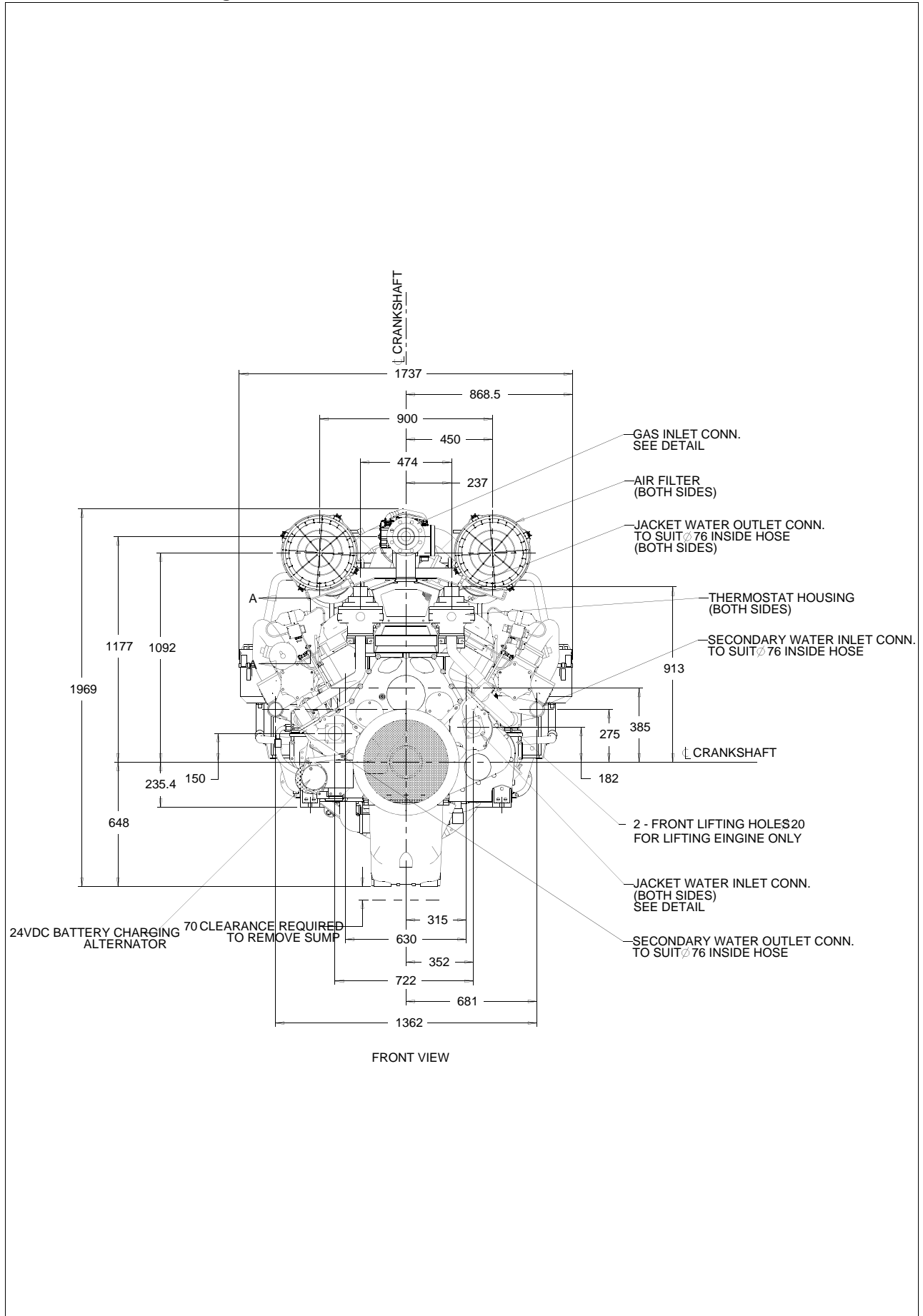

4016-61TRS1&2 Natural gas electro unit - Right view

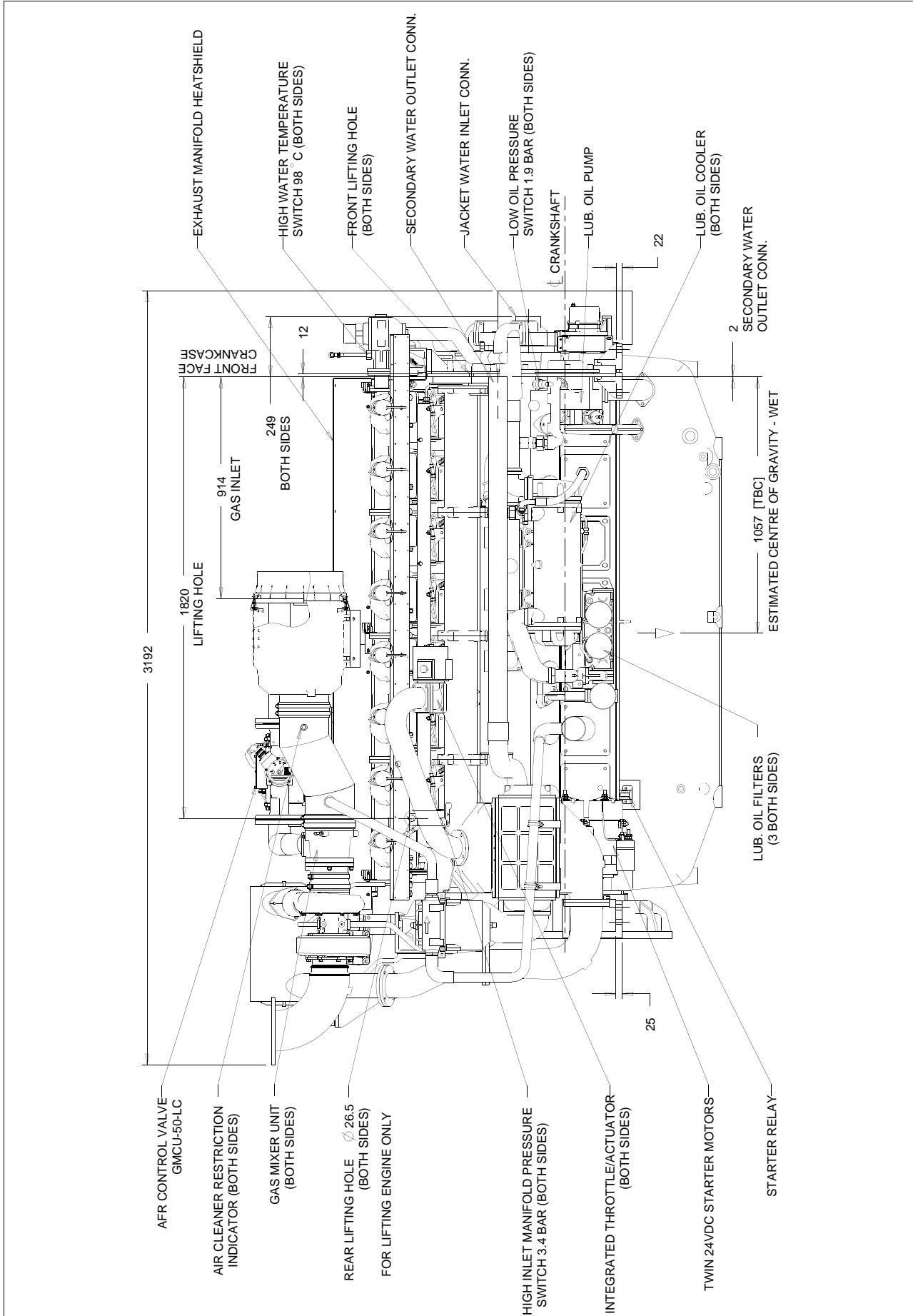

4016-61TRS1&2 Natural gas electro unit - Rear view

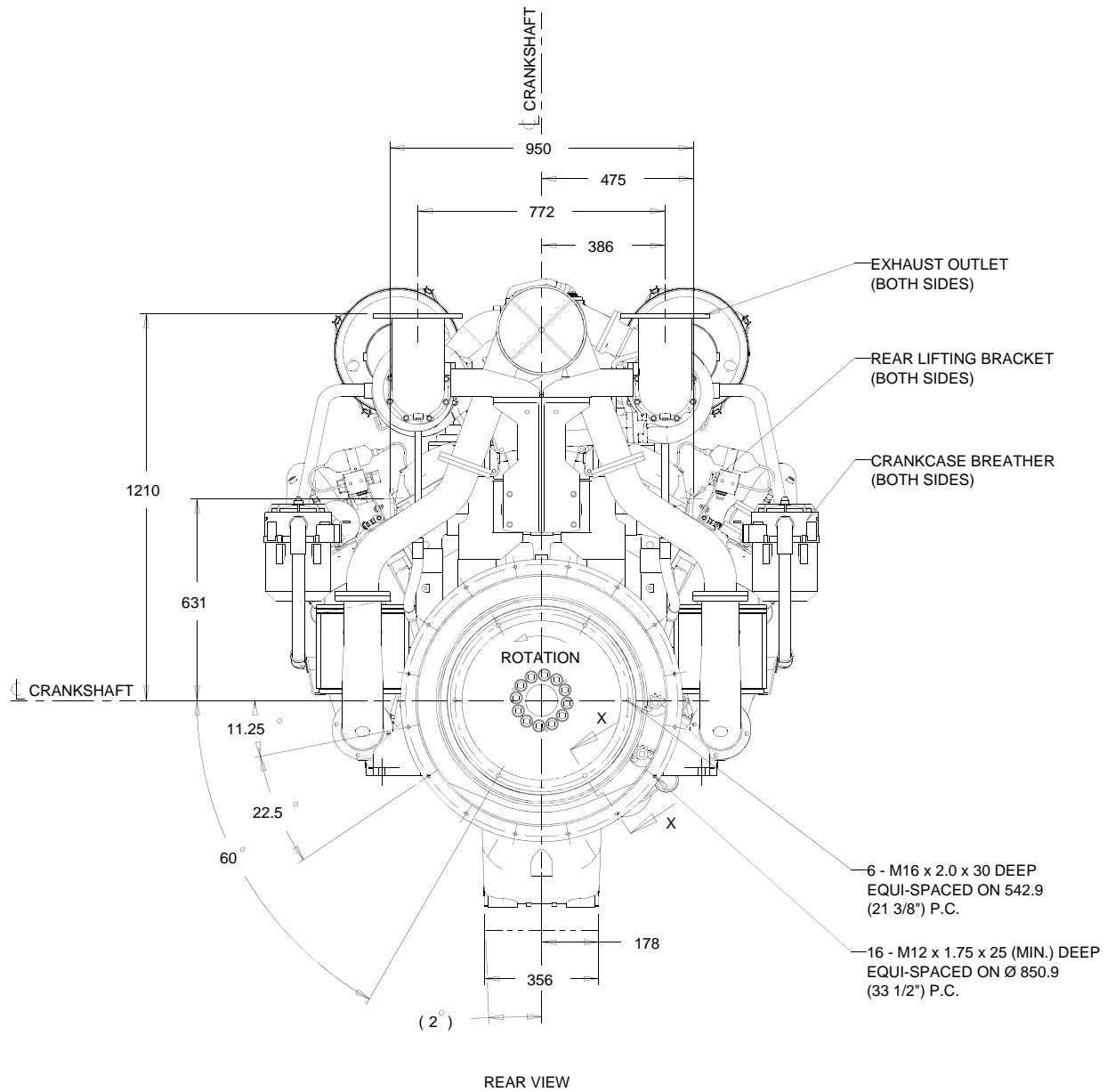

4016-61TRS1&2 Natural gas electro unit - SAE Flywheel, Exhaust Outlet and Support Pads

NOTE *
IGNITION AND KNOCK SENSOR CONNECTIONS ARE FOR INTEGRATED HARNESS (SUPPLIED FITTED) FROM B BANK WIRING RAIL

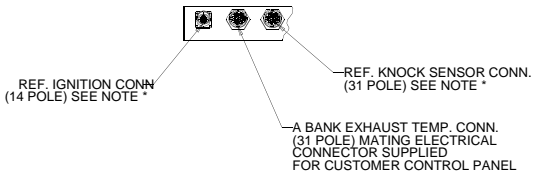

SECTION A-A
SCALE 1:5

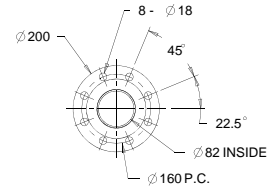

GAS INLET CONNECTION
(BS EN 1092-1 DN80 PN 16)
SCALE 1:5

3

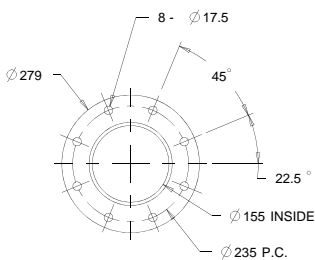
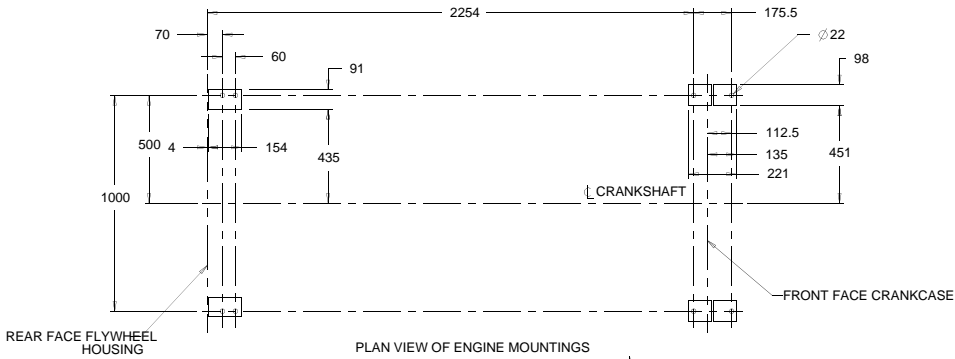
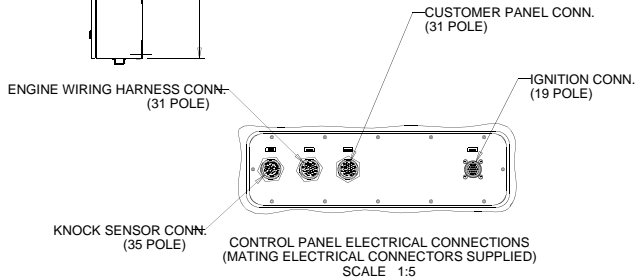
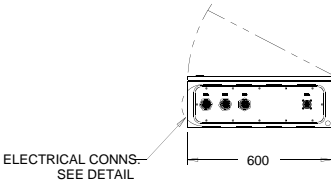
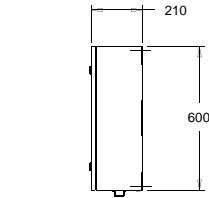
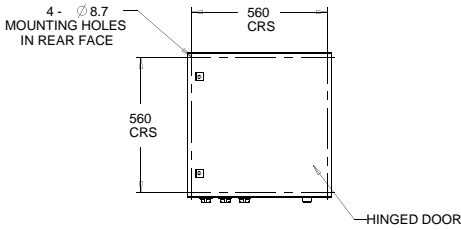
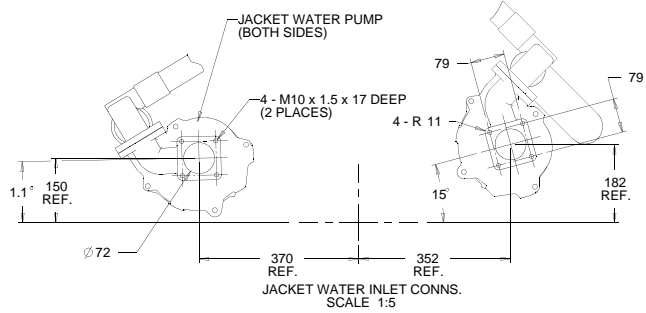
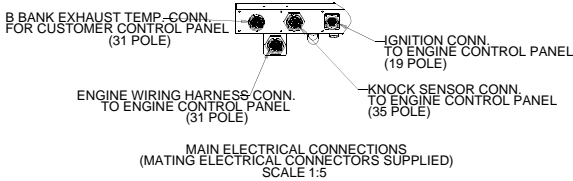

EXHAUST OUTLET CONNECTION
(6" BS 10 TABLE D)
SCALE 1:5

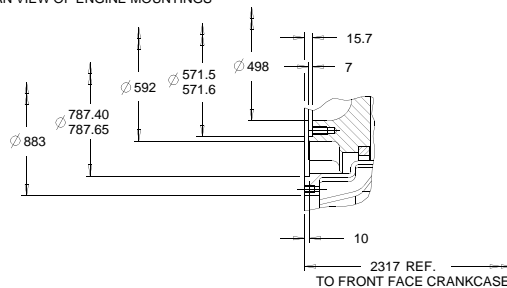

SECTION X-X
SAE J620 SIZE 18 FLYWHEEL
SAE J617 No. 00 FLYWHEEL HOUSING
METRIC TAPPINGS
SCALE 1:5

4016-61TRS1&2 Natural gas co-generation unit - Left view

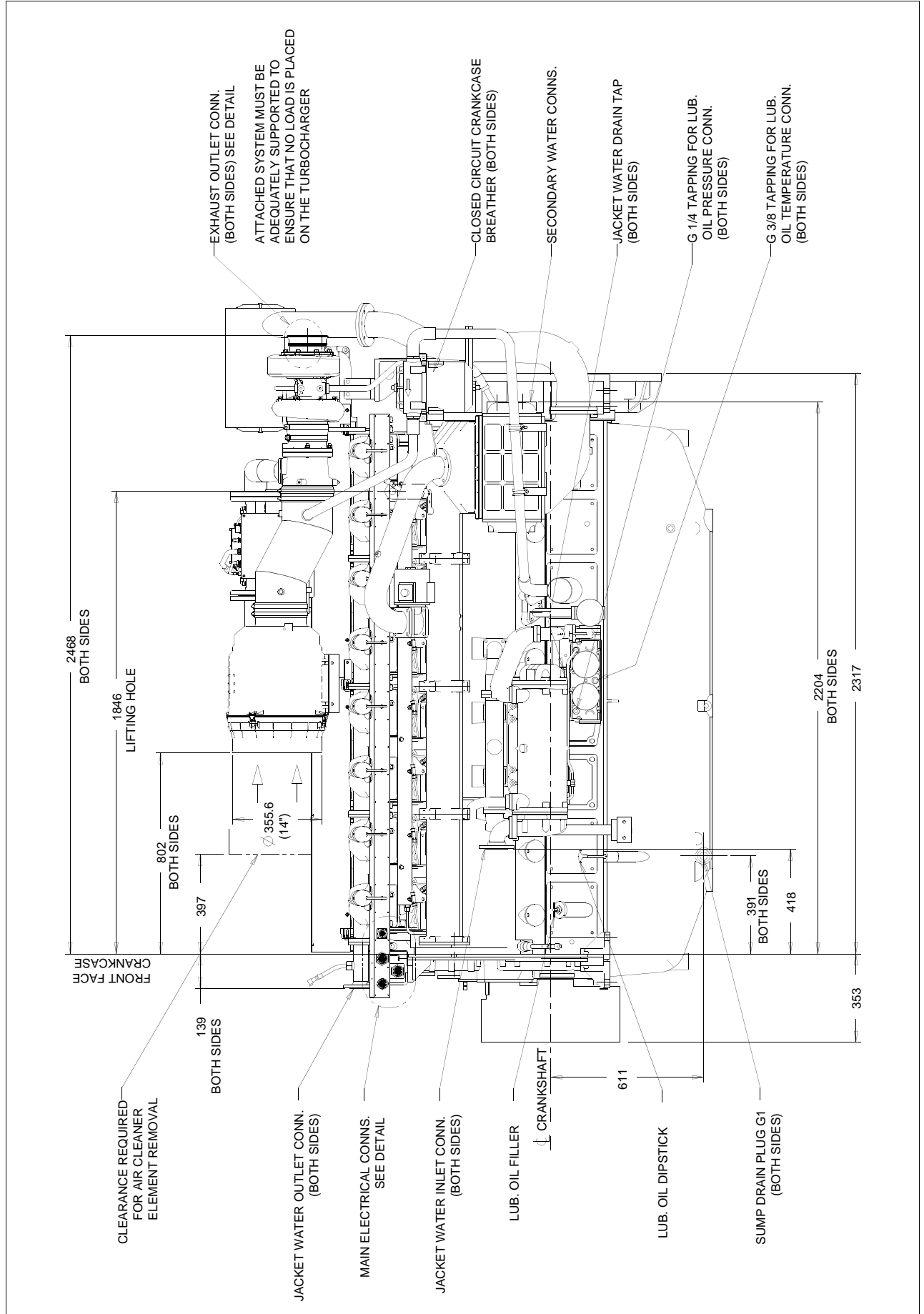

4016-61TRS1&2 4016-61TRS1&2 Natural gas co-generation - Front view

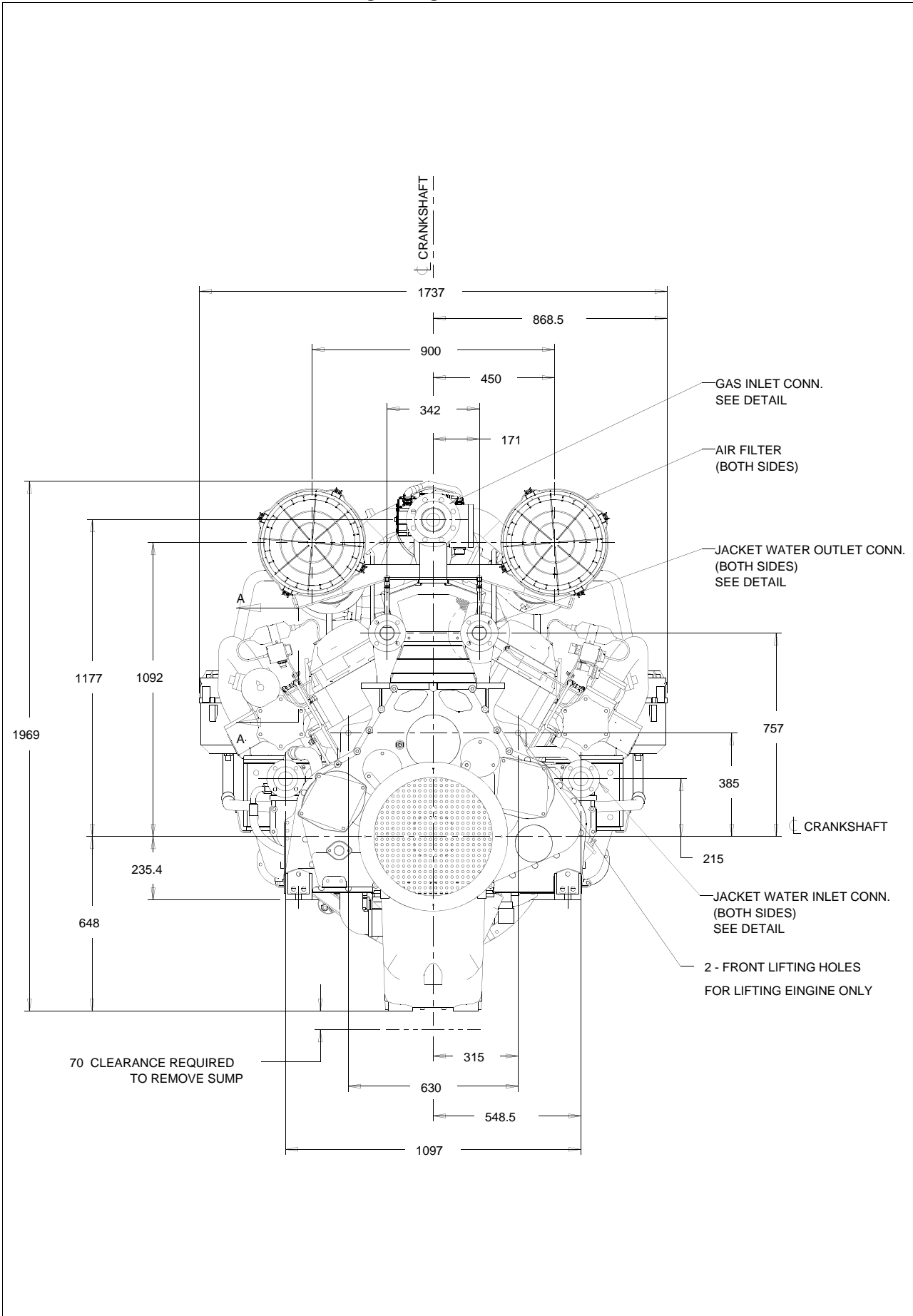

4016-61TRS1&2 4016-61TRS1&2 Natural gas co-generation - Right view

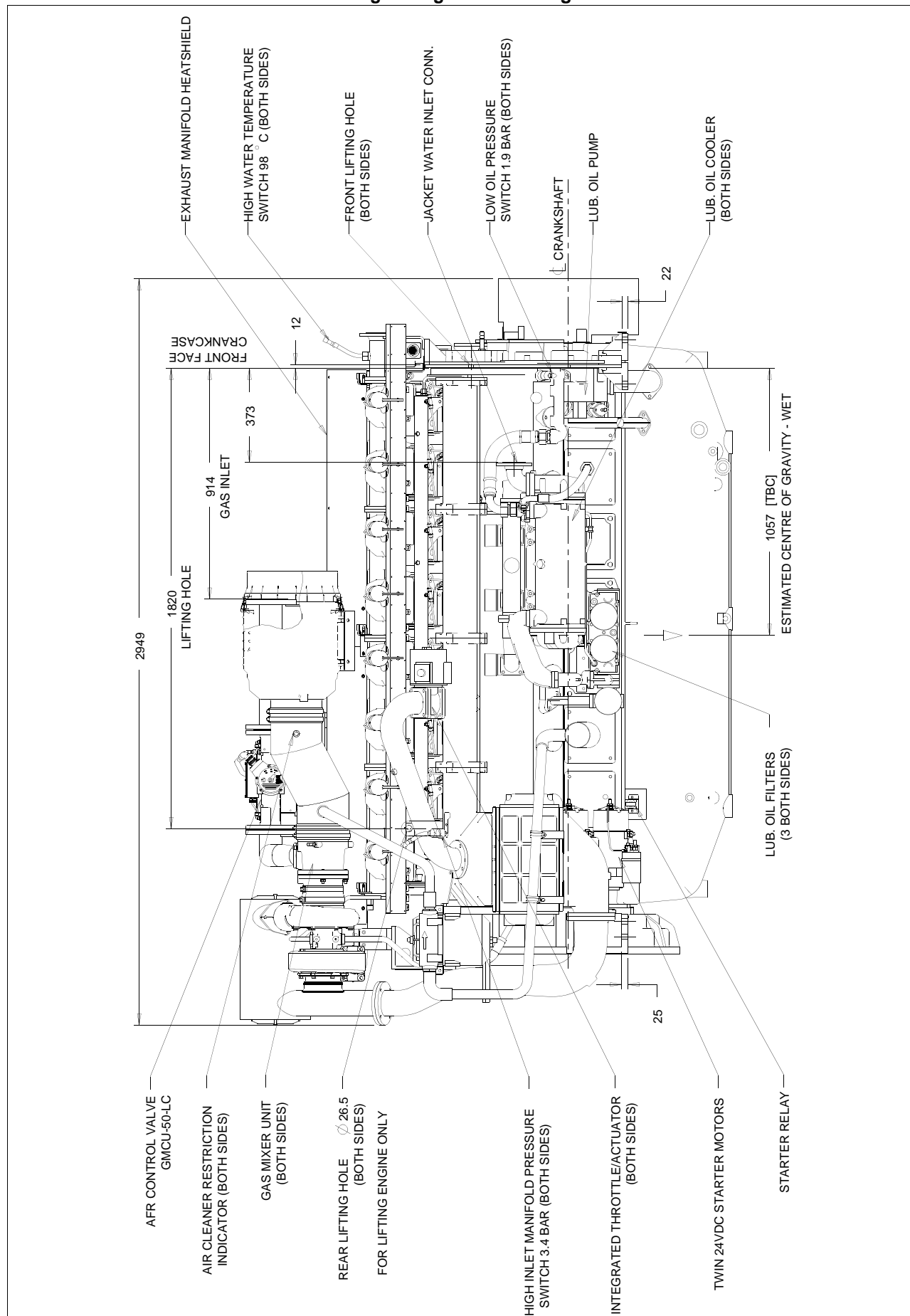

4016-61TRS1&2 Natural gas co-generation - Rear view

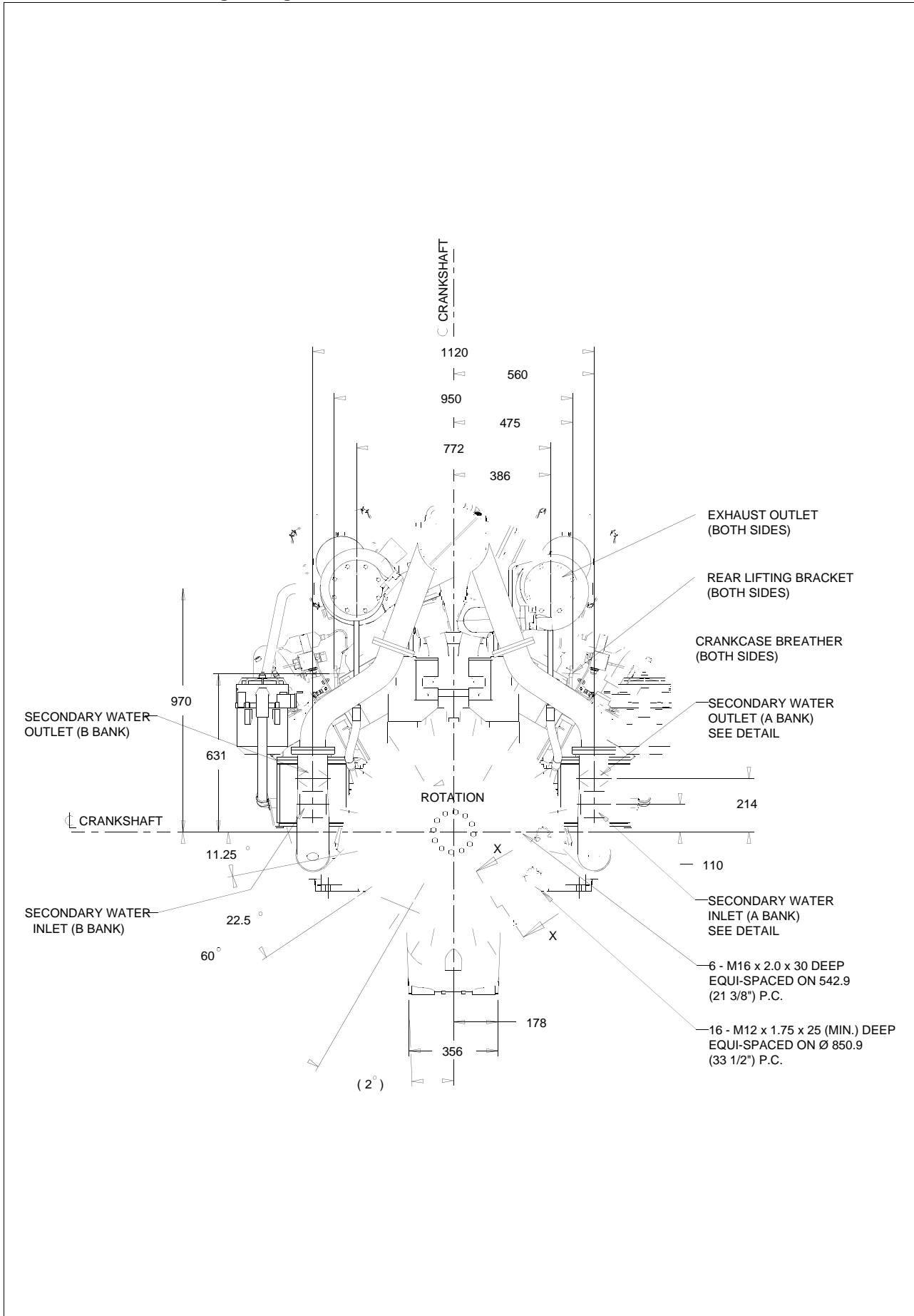

4016-61TRS1&2 Natural gas co-generation - SAE Flywheel, Exhaust Outlet and Support Pads

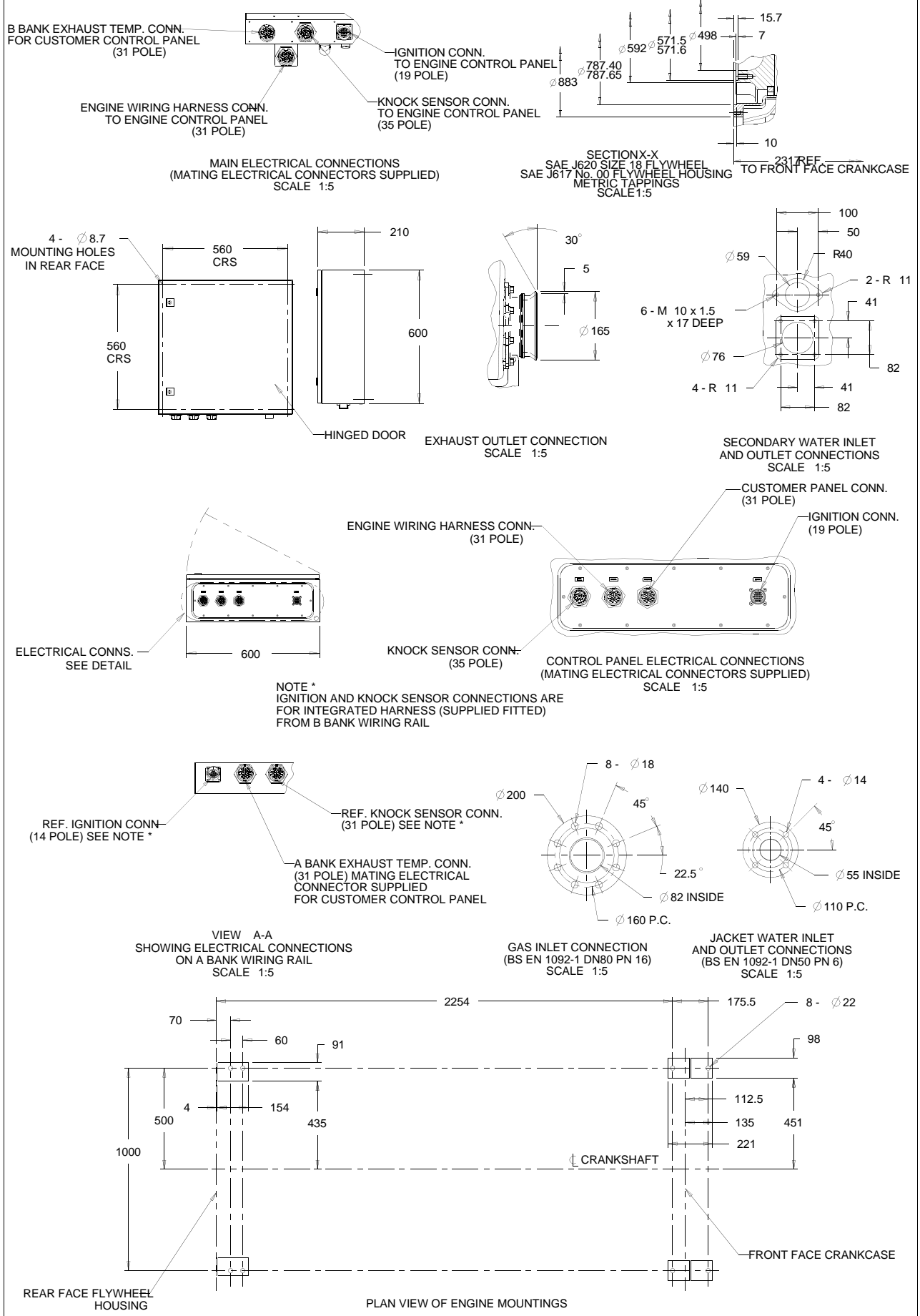

Derate tables

Note: Standard conditions for the following derate charts are:

50 °C inlet manifold temperature; 120 m altitude; TA Luft NOx emissions (500 Nm²)

Ambient/inlet manifold temperature, TRS1

Ambient and Inlet Manifold Temperature Derate - 4016-61TRS1

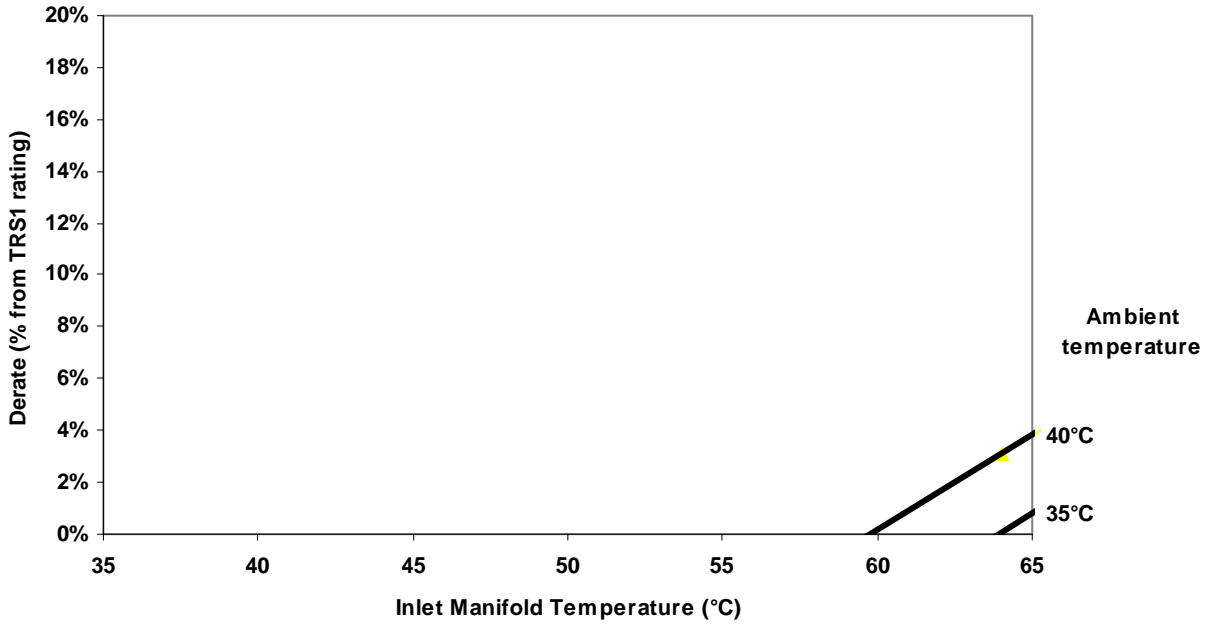

Ambient / Altitude, TRS1

Ambient and Altitude Derate - 4016-61TRS1

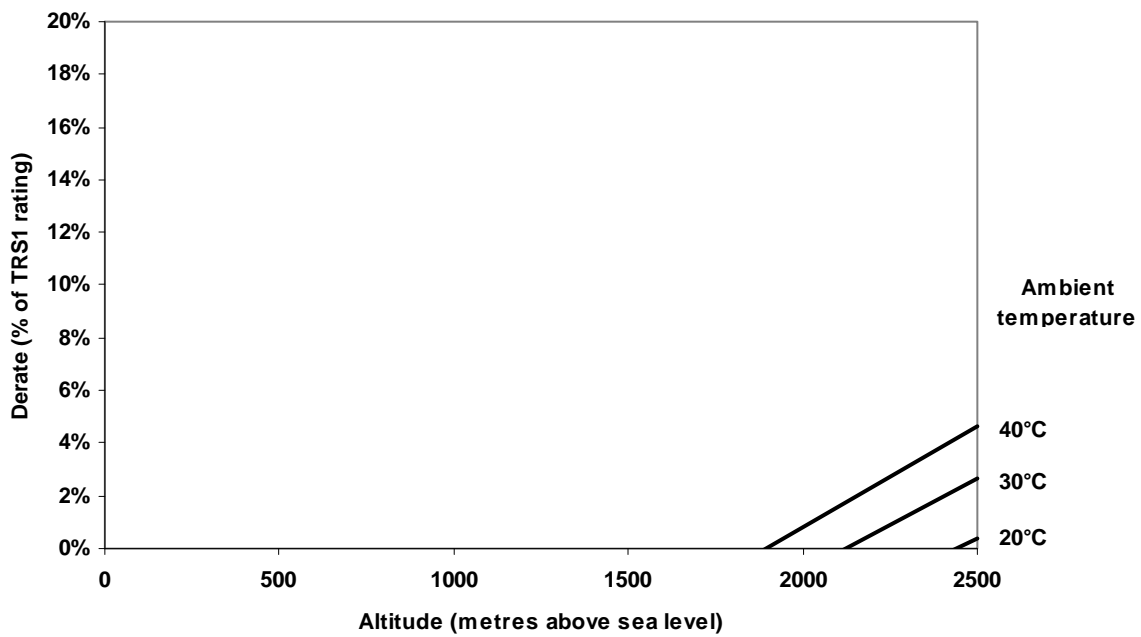

Ambient / Inlet manifold temperature, TRS2

Ambient and Inlet Manifold Temperature Derate - 4016-61TRS2

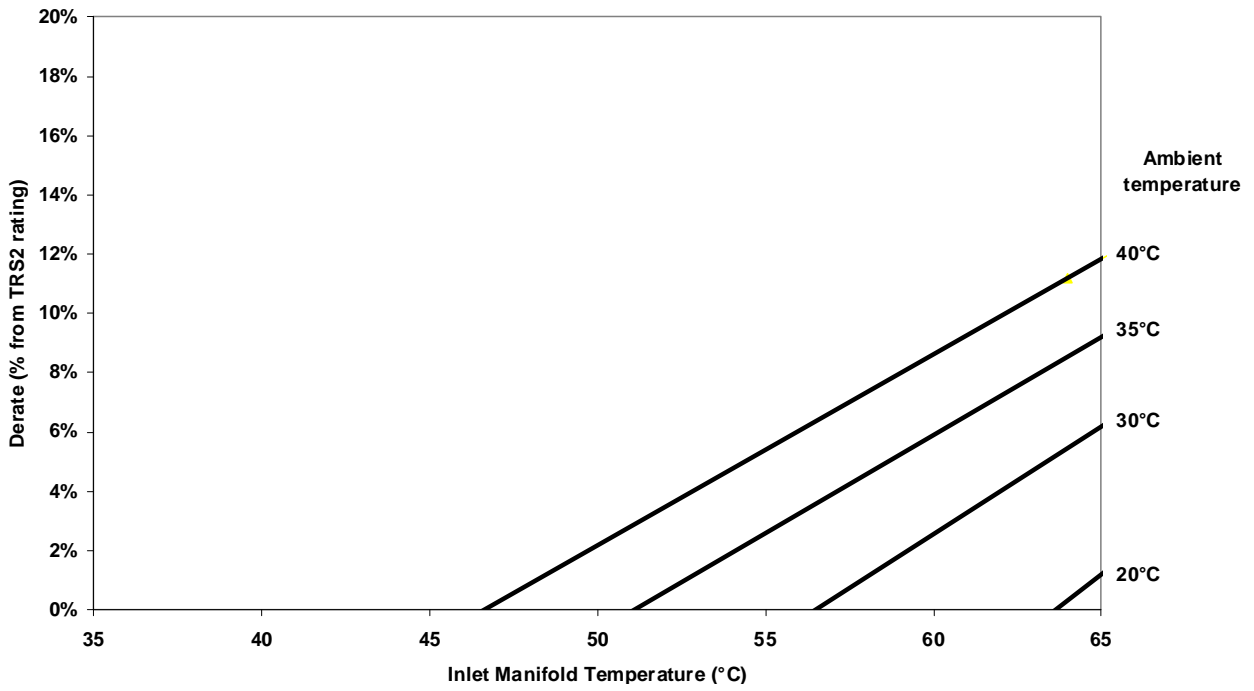

Ambient/altitude, TRS2

Derate Chart - Ambient and Altitude
 45°C inlet manifold temperature
 95°C jacket water outlet temperature

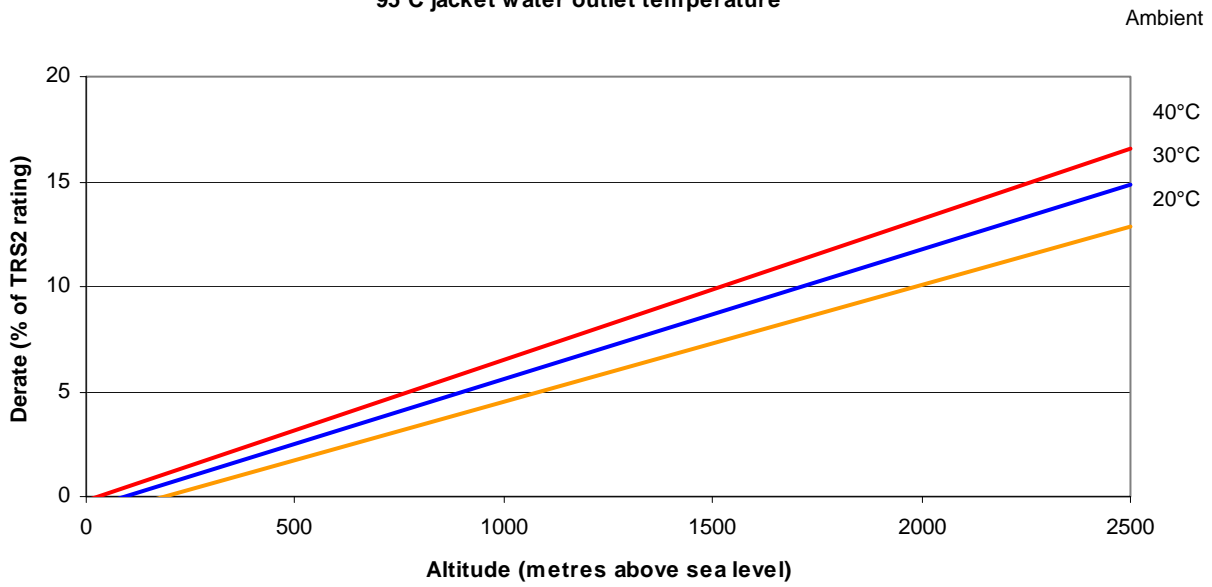

Induction system

Maximum air intake restriction of engine:

- clean filter 127 mm H₂O
- dirty filter 380 mm H₂O
- air filter type 2 of dry type

Exhaust emissions data

Ambient temperature of 25 °C

Emissions at continuous baseload rating.

If the engine is to operate in ambient conditions other than test conditions then suitable adjustments may be necessary for any change in inlet air temperature or barometric pressure.

Designation		TRS1	TRS2
Oxygen (O ₂)	%	9,2	9,4
Oxides of Nitrogen (NOx)	mg/Nm ³	460	480
Hydrocarbons (THC)	mg/Nm ³	1502	1410
Carbon Monoxide (CO)	mg/Nm ³	860	870
Lambda		1,7	1,7

Designation		Cogeneration unit		Gas unit	
		TRS1	TRS2	TRS1	TRS2
Mass flow data					
Combustion air (25 °C)	kg/h	4852	5598	4909	5662
Volume flow data					
Combustion air (25 °C)	m ³ /h	4098	4728	4146	4782

Exhaust system

Designation	Units	TRS1	TRS2
Maximum back pressure for total system	mm H ₂ O	600	400

Exhaust outlet flange size 2 x 152 mm

For recommended pipe sizes see the Installation Manual.

Designation	Units	Cogeneration unit		Electro unit	
		TRS1	TRS2	TRS1	TRS2
Exhaust gas volume flow (100 kPa)					
Exhaust gas flow (at turbo exit temperature)	m ³ /h	10816	12395	11053	12632
Exhaust gas mass flow	kg/h	4932	5652	5040	5760

Electrical system

Type .. insulated return
Alternator voltage .. 24V with integral regulator
Alternator output ... 32A at stabilised output 28 A at 20°C ambient
Starter motor voltage .. 24V
Starter motor power .. 16,4kW
Number of teeth on flywheel .. 156
Number of teeth on starter motor .. 12
Minimum cranking speed .. 120 rev/min
Starter motor solenoid pull-in current ... 26,8A at 24V
Starter motor solenoid hold-in current... 9A at 24V

Engine mountings

Maximum static bending moment at rear face of block. ... 1356 kg
Maximum permissible overhung load on flywheel. 850 kg

Starting requirements temperature down to 0°C

Oil: .. See page 2, Lubrication system
Starter: .. 2 x 24 Volts
Battery: .. 4 x 12V total Ah 143
In-rush current to starter: .. 1000 amps
Cranking current: .. 600 amps
Starter cable size: .. 120 mm²
Maximum length: .. 6 m

- The battery capacity is defined by the 20 hour rate
- The starting ability of an engine with an immersion heater will be improved by approx. 10°C and the start aid specification can be modified accordingly the oil specification should be for the minimum ambient temperature as the oil will not be warmed by the immersion heater
- Breakaway current is dependant on battery capacity available. Cables should be capable of handling the transient current which may be up to double the steady cranking current.

Noise Data

Noise levels

The figures for total noise levels are typical for an engine running at the continuous baseload power rating in a semi-reverberant environment and measured at a distance of one metre from the periphery of the engine (sound pressure level re: -20×10^{-6} pa).

Ambient noise level78 dBA

Position	Noise Level (dBA)
1	106.4
2	105.4
3	103.4
4	102.1
5	99.8
6	102.8
7	105.6
8	104.3
9	104.6
10	105.0
11	103.5

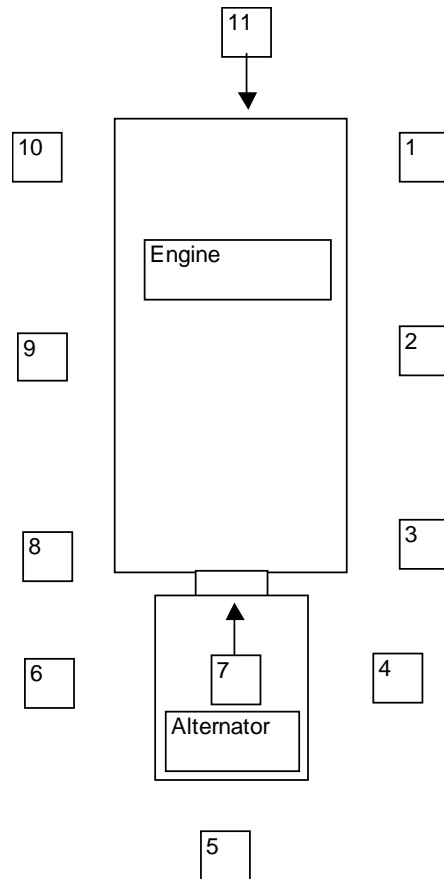
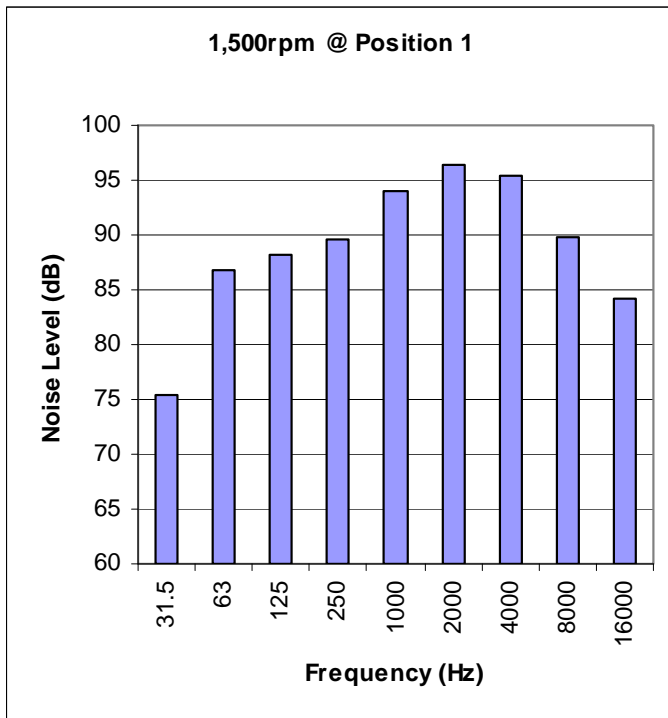

The information given on this Technical Data Sheet is for guidance only. For ratings other than those shown, please contact Perkins Engines Company Limited.



Perkins Engines Company Limited
 Peterborough PE1 5NA United Kingdom
 Telephone +44 (0) 1733 583000
 Fax +44 (0) 1733 582240
 www.perkins.com

Distributed by

All information in the document is substantially correct at the time of printing but may be subsequently altered by the company.